



Index

A

| | |
|--|-------------|
| Adson Bone Rongeur | 13-109 |
| Adson Drill Guide and Dura Protecting Forcep | 13-3 |
| Adson Elevator | 13-77 |
| Aiming Device For DHS | 33-16 |
| Alderdyce Elevator | 13-79 |
| Alexander Bone Chisel | 13-32 |
| Alexander Bone Gouge | 13-32 |
| Alexander Periosteal Raspatory | 13-74 |
| Amputating and Resection Saws | 13-2 |
| Arthroscopy Instrument | 13-4 - 13-9 |

B

| | |
|--|-----------------|
| Bacon Bone Rongeur | 13-112 |
| Bane Bone Rongeur | 13-111 |
| Barth Bone Curette | 13-66 |
| Baumgartner Wire Twisting Forcep | 13-18 |
| Bending Iron For Large Plates | 33-7 |
| Bending Iron For Small Plates | 33-7 |
| Bending Iron For Wire Drills | 33-14 |
| Bending Plier | 33-7 |
| Bending Press | 33-8 |
| Bennett Bone Lever | 13-83 |
| Bergmann Hammer | 13-45 |
| Beyer Bone Rongeur | 13-107, 13-110 |
| Bircher Meniscotomy Knife | 13-88 |
| Bircher-Ganske Meniscus and Cartilage Forcep | 13-94 |
| Blount Bone Lever | 13-87 |
| Blumenthal Bone Rongeur | 13-108 |
| Bohler Bone Cutting Forcep | 13-121 |
| Bohler Bone Rongeur | 13-110 |
| Bohler Extension Bow | 13-29 |
| Bone Chisels | 13-31, 33,38,40 |
| Bone Curettes | 13-56 - 13-66 |
| Bone Cutting Forceps | 13-119 - 13-123 |
| Bone Drills | 13-3 |
| Bone Files | 13-75 |
| Bone Gouges | 13-31, 35,37,40 |
| Bone Holding Clamps | 13-10, 13-11 |
| Bone Holding Forceps | 13-95 - 13-104 |
| Bone Levers | 13-80 - 13-87 |
| Bone Nailing Instruments | 33-3, 33-4 |
| Bone Osteotomes | 13-31 - 13-43 |
| Bone Rasps | 13-43 |
| Bone Retractor | 13-104 |
| Bone Rongeurs | 13-105 - 13-118 |
| Bone Wire Guides | 13-27, 13-28 |
| Bone Wire Tighteners | 13-27, 13-28 |
| Brand Tendon Seizing Instrument | 13-91 |
| Bruns Bone Curette | 13-58, 13-59 |
| Buck-Gramcko Bone Lever | 13-80 |
| Bunnel Hand Drill | 13-13 |
| Bunnel Tendon Stripper | 13-89 |
| Bunnel Tendon Tunnel Instrument | 13-90 |
| Bunnell-Howard Bone Holding Clamp | 13-11 |
| Burrs | 13-12, 13-14 |

C

| | |
|--|-------|
| Caroll Tendon Seizing Instrument | 13-91 |
| Chandler Bone Lever | 13-85 |
| Charriere Amputating and Resection Saw | 13-2 |

| | |
|---|--------|
| Cleveland Bone Cutting Forcep | 13-120 |
| Cleveland Bone Rongeur | 13-106 |
| Cleveland-Gardner Bone Cutting Forcep | 13-119 |
| Clips | 13-29 |
| Cloward Hibbs Spratt Spinal Fusion Bone Curette | 13-60 |
| Cobb Bone Curette | 13-63 |
| Cobb Bone Gouge | 13-37 |
| Cobb Elevator | 13-78 |
| Cobb Periosteal Raspatory | 13-70 |
| Cohen Bone Rongeur | 13-106 |
| Collin Hammer | 13-47 |
| Compression Devices | 33-13 |
| Corwin-Hegar Wire Twisting Forcep | 13-17 |
| Cottle Hammer | 13-49 |
| Cottle Kazanjian Bone Cutting Forcep | 13-119 |
| Cottle-Jansen Bone Rongeur | 13-111 |
| Counter Sinks | 33-9 |
| Coupling Screw For DHS | 33-17 |
| Cushing Burr for Hudson Hand Drill | 13-12 |

D

| | |
|--|---------------|
| Dale Bone Rongeur | 13-118 |
| Daubenspeck Bone Curette | 13-61 |
| Defourmentel Bone Rongeur | 13-109 |
| Demel Bone Wire Guide | 13-27 |
| Demel Bone Wire Tightener | 13-28 |
| Dental Handle | 33-2 |
| Depth Gauges | 33-10 |
| DHS Instruments | 33-16, 33-17 |
| Dingmann Meniscus and Cartilage Forcep | 13-94 |
| Dingmann-Modif Meniscus and Cartilage Forcep | 13-94 |
| Double & Universal Drill Guides | 33-12 |
| Doyen Hammer | 13-46 |
| Doyen Periosteal Raspatory | 13-72 |
| Drill Bits | 33-2 |
| Drill Guide | 33-11 - 33-14 |
| Drill Holders | 33-2 |
| Dynamic Hip Screw Instruments | 33-16, 33-17 |

E

| | |
|---------------------|---------------|
| Echlin Bone Rongeur | 13-113 |
| Elevators | 13-77 - 13-79 |
| Extension Bows | 13-29, 13-30 |
| Extraction Hook | 33-4 |

F

| | |
|---------------------------------------|---------------|
| Farabeuf Bone Holding Forcep | 13-99 |
| Farabeuf Periosteal Raspatory | 13-68 |
| Farabeuf-Collin Periosteal Raspatory | 13-69 |
| Farabeuf-Lambotte Bone Holding Forcep | 13-99 |
| Feldheim Nail Instrument | 13-44 |
| Fergusson Bone Holding Forcep | 13-96 |
| Finger Ring Saws | 13-124 |
| Fisch Bone Rongeur | 13-112 |
| Fischer Tendon Tunnel Instrument | 13-90 |
| Flat Nose Pliers | 13-19 - 13-22 |
| Friedman Bone Rongeur | 13-105 |
| Friedman-Vickers Bone Rongeur | 13-105 |
| Frosch Bone Holding Forcep | 13-96 |
| Frykholm Bone Rongeur | 13-115 |



Index

G

| | | | |
|-----------------------------------|--------|---|--------------|
| Gardner Hammer | 13-55 | Lane Bone Holding Forcep | 13-102 |
| Gerster Bone Holding Clamp | 13-11 | Lane Bone Lever | 13-86 |
| Gerster-Lowman Bone Holding Clamp | 13-10 | Lane Screw Driver | 33-5 |
| Gerzog Hammer | 13-55 | Lane Trethowan Bone Lever | 13-86 |
| Gouges | 13-38 | Lange-Hohmann Modif Bone Lever | 13-84 |
| Guide Shaft For DHS | 33-17 | Langenbeck Amputating and Resection Saw | 13-2 |
| Guide Sleeve For DHS | 33-16 | Langenbeck Bone Holding Forcep | 13-96 |
| Guide Wire For DHS | 33-16 | Langenbeck Elevator | 13-77, 13-78 |
| Guleke Bone Rongeur | 13-111 | Langenbeck Periosteal Raspatory | 13-68 |

H

| | | | |
|---------------------------------|---------------|--------------------------------------|---------------|
| Hackstock Flat Nose Pliers | 13-22 | Lead Hands | 13-44 |
| Hajek Hammer | 13-50 | Leksell-Stille Bone Rongeur | 13-115 |
| Hakansson Bone Rongeur | 13-106 | Lempert Bone Rongeur | 13-108 |
| Halle Bone Curette | 13-64 | Lewin Bone Holding Forcep | 13-95 |
| Hammers | 13-34 - 13-43 | Lexer Bone Gouge | 13-34, 13-38 |
| Hand Drills | 13-12 - 13-15 | Lexer Bone Osteotome | 13-35, 13-36 |
| Handle For AO Attachment | 33-2 | Lexer Gouges | 13-38 |
| Hartmann Bone Rongeur | 13-107 | Liston Bone Cutting Forcep | 13-119 |
| Harvey Wire Cutting Plier | 13-23 | Liston-Key Bone Cutting Forcep | 13-122 |
| Hatfield Bone Curette | 13-63 | Littauer-Liston Bone Cutting Forcep | 13-119 |
| Hemingway Bone Curette | 13-66 | Lloyd Impactor | 33-4 |
| Herz Tendon Seizing Instrument | 13-91 | Loute Bone Wire Tightner | 13-27 |
| Hexagonal Key | 33-8 | Lowman-Baby Bone Holding Clamp | 13-11 |
| Hexagonal Screw Driver | 33-8, 33-15 | Lowman-Hoglung Bone Holding Clamp | 13-11 |
| Hey Groves Bone Holding Forcep | 13-103 | Lucae Hammer | 13-47 |
| Hibbs Bone Chisel | 13-40 | Lucas Bone Curette | 13-66 |
| Hibbs Bone Gouge | 13-40 | Luer Bone Rongeur | 13-109 |
| Hibbs Bone Osteotome | 13-40 | M | |
| Hohmann Bone Lever | 13-81, 13-82 | Mallets | 13-45 - 13-55 |
| Hohmann-Aldinger Bone Lever | 13-84 | Markwalder Bone Cutting Forcep | 13-119 |
| Hoke Bone Osteotome | 13-43 | Marquardt Bone Rongeur | 13-110 |
| Holding Forcep For Small Plates | 33-7 | Martin Meniscus and Cartilage Forcep | 13-94 |
| Hooklet | 33-10 | Martin Wire Twisting Forcep | 13-17 |
| House Bone Curette | 13-66 | Martin-Cushing Periosteal Raspatory | 13-67 |
| Hub | 33-13 | Martin-Diamant Wire Cutting Plier | 13-25 |
| Hudson Hand Drill | 13-12 | Martin-Hoen Periosteal Raspatory | 13-67 |

I

| | | | |
|--------------------------------------|--------------|--|-------|
| Ideal Nail Instrument | 13-44 | Martini Bone Curette | 13-65 |
| Impactor For DHS | 33-17 | Martin-Langenbeck Elevator | 13-77 |
| Insert Drill Sleeve | 33-10 | Martin-Langenbeck Periosteal Raspatory | 13-67 |
| Instruments For Bone Plates & Screws | 33-7, 33-8 | Martin-TC Wire Twisting Forcep | 13-17 |
| Instruments For Dynamic Hip Screws | 33-16, 33-17 | Matson Periosteal Raspatory | 13-74 |

J

| | | | |
|---------------------|----------------|------------------------------|--------|
| Jansen Bone Curette | 13-65 | Mayfield Bone Rongeur | 13-110 |
| Jansen Bone Rongeur | 13-107, 13-111 | Mc Indoe Bone Cutting Forcep | 13-120 |

K

| | | | |
|---|--------|--------------------------------|--------|
| Kern Bone Holding Forcep | 13-97 | McDonald Elevator | 13-79 |
| Kirschner Extension Bow | 13-30 | Mead Bone Rongeur | 13-106 |
| Kleinert-Kutz Bone Cutting Forcep | 13-120 | Mead Hammer | 13-51 |
| Kleinert-Kutz Bone Rongeur | 13-112 | Meniscotomy Knives | 13-88 |
| Kleinert-Kutz Tendon Seizing Instrument | 13-92 | Meniscus and Cartilage Forceps | 13-94 |
| Kuentscher Bone Nailing Instrument | 33-3 | Meyer Reposition Forcep | 13-93 |

L

| | | | |
|-----------------------------------|--------------|------------------------------|--------|
| Lambert-Lowman Bone Holding Clamp | 13-11 | Mini Drill Sleeve | 33-10 |
| Lambotte Bone Holding Forceps | 13-98, 13-99 | Mini-Friedman Bone Rongeur | 13-105 |
| Lambotte Bone Osteotome | 13-42 | Mini-Hohmann Bone Lever | 13-80 |
| Lambotte Periosteal Raspatory | 13-72 | Mini-Lambotte Bone Osteotome | 13-41 |
| Lampert Bone Rongeur | 13-108 | Mini-Lexer Bone Gouge | 13-35 |
| | | Mini-Lexer Bone Osteotome | 13-35 |
| | | Mod. Martin Finger Ring Saw | 13-124 |
| | | Mod. USA Bone Curette | 13-64 |
| | | Murphy-Lane Bone Lever | 13-85 |



Index

N

| | | | |
|------------------------|---------------|--------------------------|--------|
| Nail Instruments | 13-44, 13-124 | Semb Bone Cutting Forcep | 13-122 |
| Neff Meniscotomy Knife | 13-88 | Semb Bone Holding Forcep | 13-97 |
| Neutral Drill Guides | 33-14 | Semb Bone Rongeur | 13-114 |

O

| | | | |
|----------------------------|--------------|---------------------------|--------------|
| Olivecrona Bone Rongeur | 13-108 | Semb Periosteal Raspatory | 13-73, 13-74 |
| Ombredanne Hammer | 13-45 | Sequestrum Forceps | 13-93 |
| Optional Instruments | 33-18 | Side Pin Cutter –TC | 13-125 |
| Osteosynthesis Instruments | 33-9 - 33-12 | Simon Bone Curette | 13-64 |

P

| | | | |
|----------------------------|---------------|-------------------------------------|-----------------|
| Parallel Aiming Device | 33-9 | Sleeve For Screw Driver | 33-5 |
| Parham Bone Wire Guide | 13-28 | Slotted Hammer | 33-4 |
| Parham Bone Wire Tightener | 13-28 | Smillie Bone Lever | 13-85 |
| Partsch Bone Chisel | 13-32 | Smillie Meniscotomy Knife | 13-88 |
| Partsch Bone Gouge | 13-32 | Smith Petersen Bone Rongeur | 13-113 |
| Partsch Hammer | 13-51 | Sypert Bone Rongeur | 13-118 |
| Patella Forcep | 13-93 | Smith-Petersen Bone Gouge | 13-39 |
| Penner Nail Instrument | 13-124 | Smith-Petersen Bone Osteotome | 13-39 |
| Percy Bone Retractor | 13-104 | Socket & Combination Wrenches | 33-13 |
| Periosteal Raspatories | 13-67 - 13-74 | Spanner | 33-13 |
| Perthes Reamer | 13-3 | Spare Blade for Saw | 13-2 |
| Philips Screw Driver | 33-5, 33-15 | Spratt Bone Curette | 13-58 |
| Pin Cutter | 13-128 | Steinbach Hammer | 13-49 |
| Pin Cutter (Large) | 13-127 | Steinmann Pins | 13-29 |
| Pin Cutter (Medium) | 13-126 | Steinmann Tendon Seizing Instrument | 13-91 |
| Pin Cutter (Small) | 13-126 | Stellbrink Bone Rongeur | 13-105 |
| Pin Cutter Double Action | 13-125 | Stille Bone Chisel | 13-33 |
| Pin Wrench | 33-13 | Stille Bone Gouge | 13-33 |
| Plate Bending Plier | 33-18 | Stille Bone Osteotome | 13-33 |
| Pointed Drill Guide | 33-11 | Stille Bone Rongeur | 13-114 |
| Putti Bone Rasp | 13-43 | Stille Hand Drill | 13-14 |
| | | Stille-Liston Bone Cutting Forcep | 13-123 |
| | | Stille-Luer Bone Rongeur | 13-115 - 13-117 |
| | | Stille-Ruskin Bone Rongeur | 13-116 |
| | | Stille-Sherman Hand Drill | 13-14 |

R

| | | | |
|-----------------------------------|--------|----------------------------|--------------|
| Radolf Nail Instrument | 13-124 | | |
| Ralk Hand Drill | 13-13 | T | |
| Reamers | 13-3 | Tampers | 13-76 |
| Reill Reposition Forcep | 13-93 | Tap & Drill Sleeve | 33-8, 33-11 |
| Reill Wire Cutting Pliers | 13-26 | Tap For DHS | 33-16 |
| Reposition Bone Holding Forcep | 13-95 | Tap Holders | 33-2 |
| Reposition Forceps | 13-93 | Tap Sleeve | 33-11 |
| Roettgen-Ruskin Bone Rongeur | 13-116 | Taps | 33-2, 8, 16 |
| Ruskin Bone Rongeur | 13-110 | Taylor Bone Lever | 13-87 |
| Ruskin-Liston Bone Cutting Forcep | 13-120 | Tendon Seizing Instruments | 13-91, 13-92 |
| Ruskin-Mini Bone Rongeur | 13-112 | Tendon Stripper | 13-89, 13-90 |
| | | Tendon Tunnel Instruments | 13-89, 13-90 |

S

| | | | |
|---|-------------|------------------------------|-------------|
| Salenius Meniscotomy Knife | 13-88 | Tension Device | 33-12 |
| Satterlee Amputating and Resection Saw | 13-2 | T-Handle | 33-2, 9, 17 |
| Sauerbruch Bone Rongeur | 13-117 | T-handle For DHS | 33-17 |
| Schede Bone Curette | 13-57 | Thiess Hammer | 13-50 |
| Schell Bone Rongeur | 13-111 | Threaded Guide Pin For DHS | 33-16 |
| Schneider Periosteal Raspatory | 13-69 | Tissue Protector Sleeve | 33-9 |
| Schneider-Sauerbruch Periosteal Raspatory | 13-69 | Traction Hook | 13-30 |
| Schumacher (Wagner) Bone Lever | 13-84 | Triple Combo Reamer For DHS | 33-16 |
| Scoville Bone Curette | 13-59 | Triple Drill Guide & Sleeve | 33-10 |
| Screw Drivers | 33-2 - 33-8 | U | |
| Screw Drivers With Interchangeable Blades | 33-15 | Uffenorde Bone Curette | 13-61 |
| Screw Holding Forcep | 33-7 | Ulrich Bone Holding Forcep | 13-100 |
| Sebileau Elevator | 13-78 | Universal Bone Rongeur | 13-108 |
| Sedillot Periosteal Raspatory | 13-68 | Universal Drill Guide | 33-12 |
| Self-Centering Bone Holding Forcep | 13-101 | Universal Wire Cutting Plier | 13-19 |



Index

V

| | |
|-------------------------------|---------------|
| Van Buren Sequestrum Forcep | 13-93 |
| Verbrugge Bone Holding Forcep | 13-104 |
| Verbrugge-Müller Bone Lever | 13-86 |
| Vickers Elevator | 13-79 |
| Vickers Hammer | 13-54 |
| Volkman Bone Curette | 13-56, 57, 65 |

W

| | |
|-----------------------------------|--------------------|
| Wagner Bone Levers | 13-85 |
| Wagner Periosteal Raspatory | 13-70 |
| Walton Finger Ring Saw | 13-124 |
| Walton-Liston Bone Cutting Forcep | 13-121 |
| Williams Screw Driver | 33-6 |
| Williger Bone Curette | 13-59, 65, 66 |
| Williger Elevator | 13-77 |
| Williger Hammer | 13-46, 13-47 |
| Williger Periosteal Raspatory | 13-72 |
| Wire Cutting Pliers | 13-19, 23, 26 |
| Wire Guides | 13-19 |
| Wire Instruments | 13-125, 128, 33-14 |
| Wire Tightners | 13-16, 33-14 |
| Wire Twisting Forcep | 13-16 - 13-18 |
| Wrench | 33-13 |
| Wrench For DHS | 33-17 |

Z

| | |
|----------------------------|--------|
| Zaufal Bone Rongeur | 13-111 |
| Zaufal-Jansen Bone Rongeur | 13-110 |
| Zielke Bone Gouge | 13-38 |



Bone Surgery - Knochenchirurgie - Cirugia ósea
Amputating and Resection Saws
Amputations und Resektionssägen
Sierras para amputación y resección

For 13-100-35



Spare saw blade
13-100-12 12 mm
13-100-15 15 mm
13-100-18 18 mm

blade width



^{1/4}
Charriere
13-100-35
35 cm



^{1/3}
Langenbeck
13-110-23
23 cm



^{1/4}
Charriere
13-112-27
27 cm



^{1/4}
Satterlee
13-114-31
31 cm



Bone Surgery - Knochenchirurgie - Cirugia ósea
Bone Drills, Reamers
Bohrinstrumente, Pfieme
Instrumental para perforar, Escariadores



1/2
13-120-14
14 cm



Perthes
13-122-18
18 cm



Perthes
13-124-21
21 cm



1/3
13-126-14
14 cm

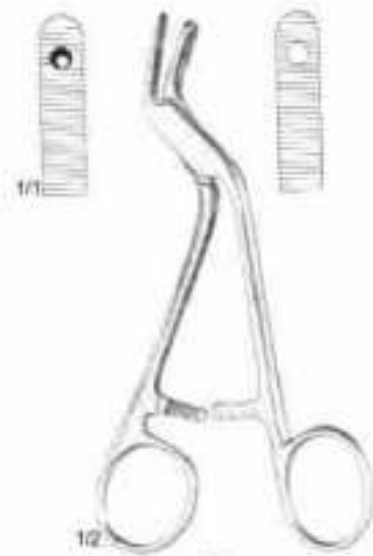

1/2
Adson
13-129-15
15 cm



Bone Surgery - Knochenchirurgie - Cirurgia ósea
Arthroscopy
Arthroskopie
Artroscopio



1/1
13-140-01
22.5 cm
Ø 4 mm

5 mm



1/1
13-140-02



13-140-03



13-140-04



13-140-05

4 mm



13-140-06

3 mm



1/1
13-140-07



13-140-08



13-140-09

3 x 4 mm



13-140-10

Ø 3 mm



13-140-11



Bone Surgery - Knochenchirurgie - Cirugia ósea
Arthroscopy
Arthroskopie
Artroscopio

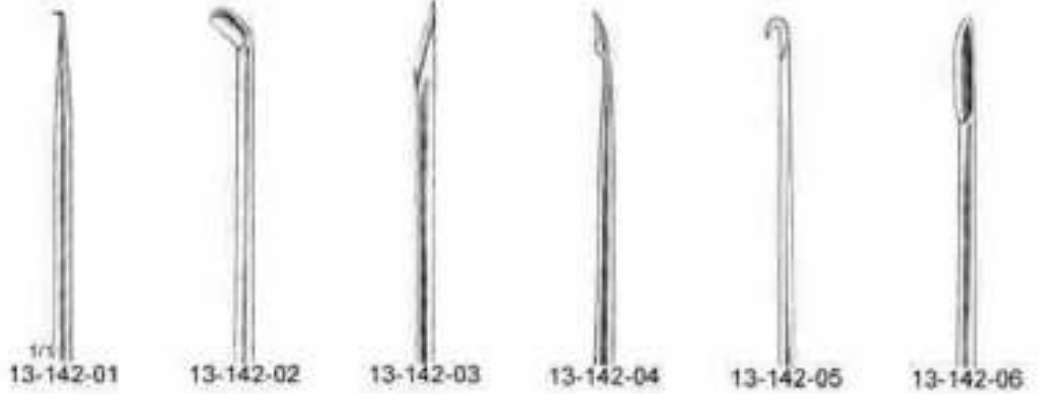

Handle only



1/1
13-142-00
12.5 cm

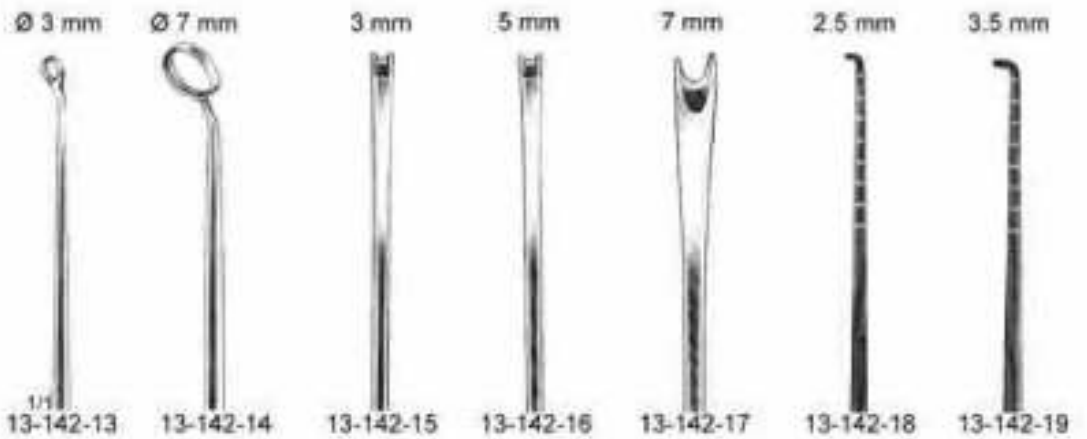





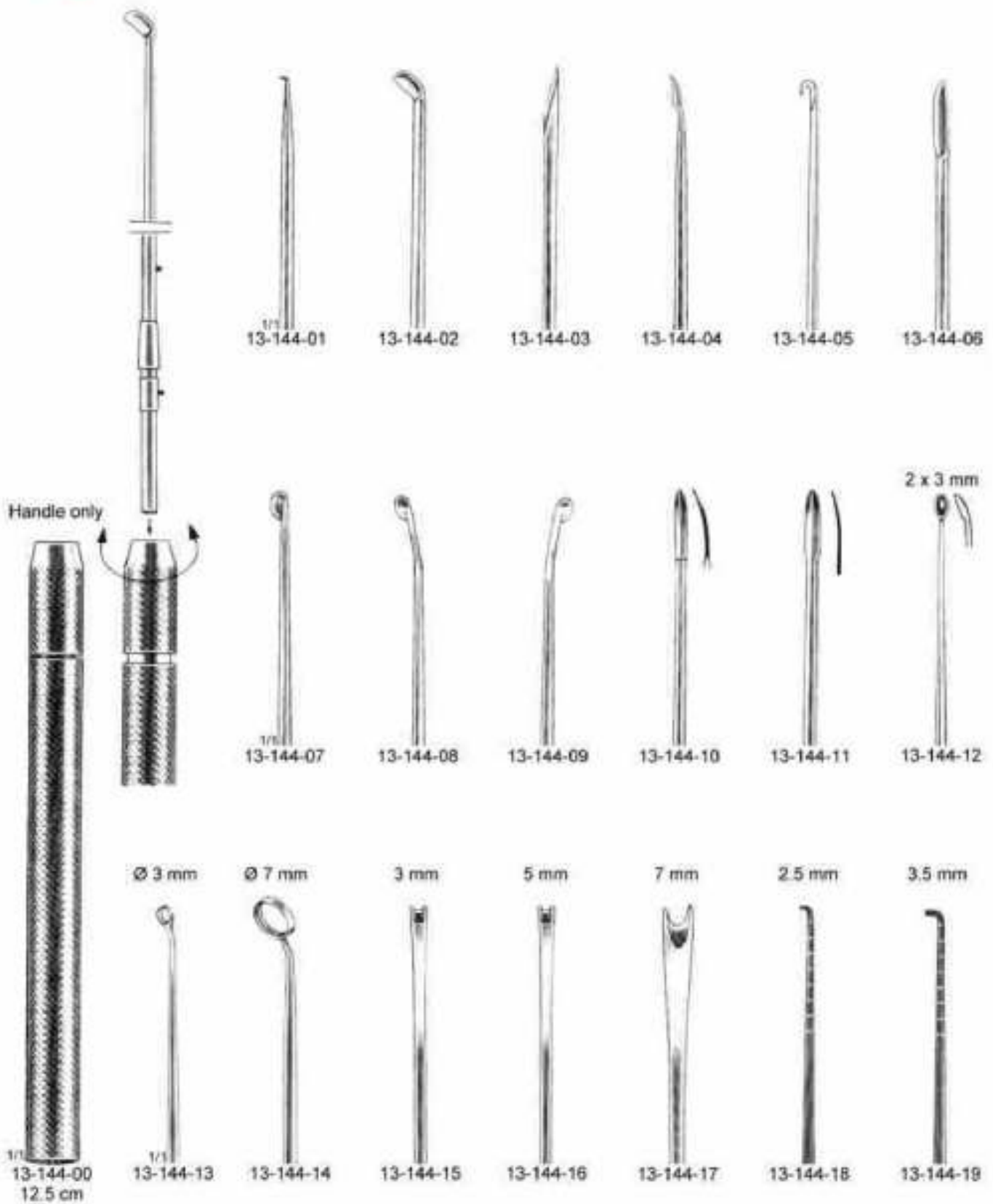

Bone Surgery - Knochenchirurgie - Cirurgia ósea
Arthroscopy
Arthroskopie
Artroscopio

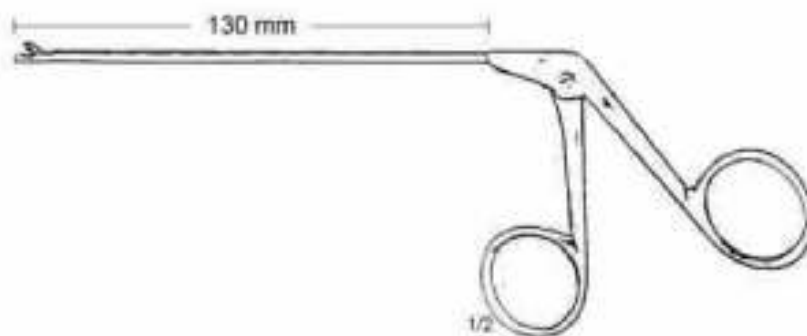

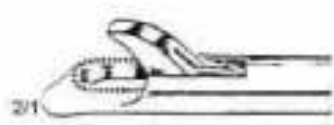
Bone Surgery - Knochenchirurgie - Cirugia ósea
Arthroscopy
Arthroskopie
Artroscopio



| | | straight | 7° curved up | 15° curved up | 30° curved right | 30° curved left |
|---|----------|-----------|--------------|---------------|------------------|-----------------|
|  | Ø 2.7 mm | 13-150-10 | 13-150-11 | 13-150-13 | 13-150-15 | 13-150-17 |
| | Ø 3.4 mm | 13-151-10 | 13-151-11 | 13-151-13 | 13-151-15 | 13-151-17 |
| | Ø 4.5 mm | 13-152-10 | 13-152-11 | 13-152-13 | 13-152-15 | 13-152-17 |
|  | Ø 2.7 mm | 13-153-10 | 13-153-11 | 13-153-13 | 13-153-15 | 13-153-17 |
| | Ø 3.4 mm | 13-154-10 | 13-154-11 | 13-154-13 | 13-154-15 | 13-154-17 |
| | Ø 4.5 mm | 13-155-10 | 13-155-11 | 13-155-13 | 13-155-15 | 13-155-17 |
|  | Ø 3.4 mm | 13-156-10 | 13-156-11 | 13-156-13 | 13-156-15 | 13-156-17 |
|  | Ø 3.4 mm | 13-157-10 | 13-157-11 | 13-157-13 | 13-157-15 | 13-157-17 |



Bone Surgery - Knochenchirurgie - Cirurgia ósea
Arthroscopy
Arthroskopie
Artroscopio

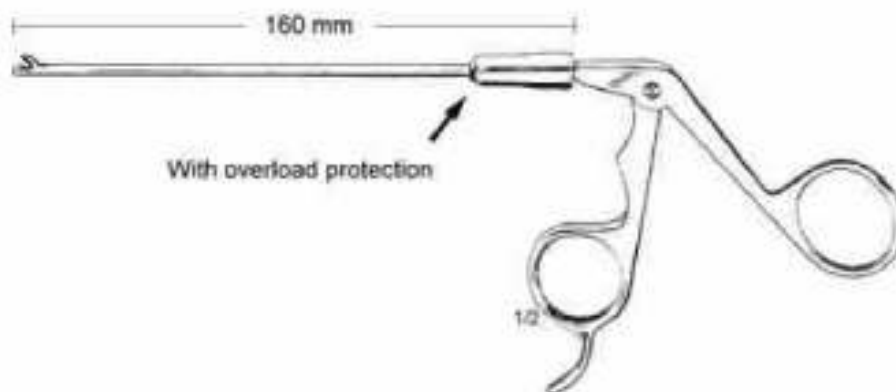

| | | straight | 7° curved up | 15° curved up | 30° curved right | 30° curved left | |
|-----|--|----------|--------------|---------------|------------------|-----------------|-----------|
| 2/1 | | Ø 2.7 mm | 13-158-10 | 13-158-11 | 13-158-13 | 13-158-15 | 13-158-17 |
| | | Ø 3.4 mm | 13-159-10 | 13-159-11 | 13-159-13 | 13-159-15 | 13-159-17 |
| | | Ø 4.5 mm | 13-160-10 | 13-160-11 | 13-160-13 | 13-160-15 | 13-160-17 |

| | | | | | | | |
|-----|--|----------|-----------|-----------|-----------|-----------|-----------|
| 2/1 | | Ø 2.7 mm | 13-161-10 | 13-161-11 | 13-161-13 | 13-161-15 | 13-161-17 |
| | | Ø 3.4 mm | 13-162-10 | 13-162-11 | 13-162-13 | 13-162-15 | 13-162-17 |
| | | Ø 4.5 mm | 13-163-10 | 13-163-11 | 13-163-13 | 13-163-15 | 13-163-17 |

| | | | | | | | |
|-----|--|----------|-----------|-----------|-----------|-----------|-----------|
| 2/1 | | Ø 3.4 mm | 13-164-10 | 13-164-11 | 13-164-13 | 13-164-15 | 13-164-17 |
|-----|--|----------|-----------|-----------|-----------|-----------|-----------|

| | | | | | | | |
|-----|--|----------|-----------|-----------|-----------|-----------|-----------|
| 2/1 | | Ø 3.4 mm | 13-165-10 | 13-165-11 | 13-165-13 | 13-165-15 | 13-165-17 |
|-----|--|----------|-----------|-----------|-----------|-----------|-----------|



Bone Surgery - Knochenchirurgie - Cirurgia ósea
Arthroscopy
Arthroskopie
Artroscopio

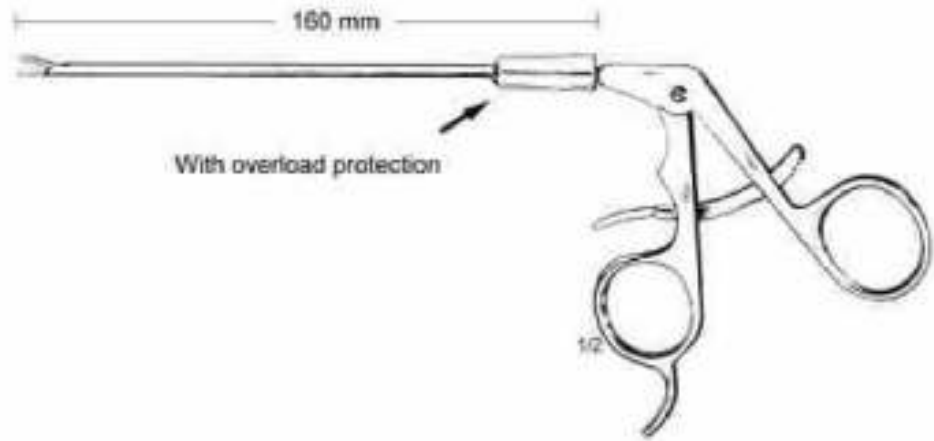

| | | | | | |
|----------|-----------|--------------|---------------|------------------|-----------------|
| | straight | 7° curved up | 15° curved up | 30° curved right | 30° curved left |
| Ø 3.4 mm | 13-170-10 | 13-170-11 | 13-170-13 | 13-170-15 | 13-170-17 |

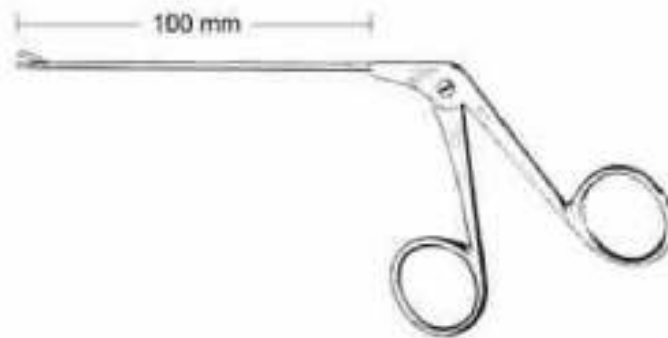

| | |
|--------|-----------|
| Ø 2 mm | 13-175-10 |
|--------|-----------|



| | |
|--------|-----------|
| Ø 2 mm | 13-175-20 |
|--------|-----------|



| | |
|--------|-----------|
| Ø 2 mm | 13-175-30 |
|--------|-----------|



| | |
|--------|-----------|
| Ø 2 mm | 13-175-40 |
|--------|-----------|



Bone Surgery - Knochenchirurgie - Cirugia ósea
Bone Holding Clamps
Knochenhalteklammern
Pinzas porta - huesos

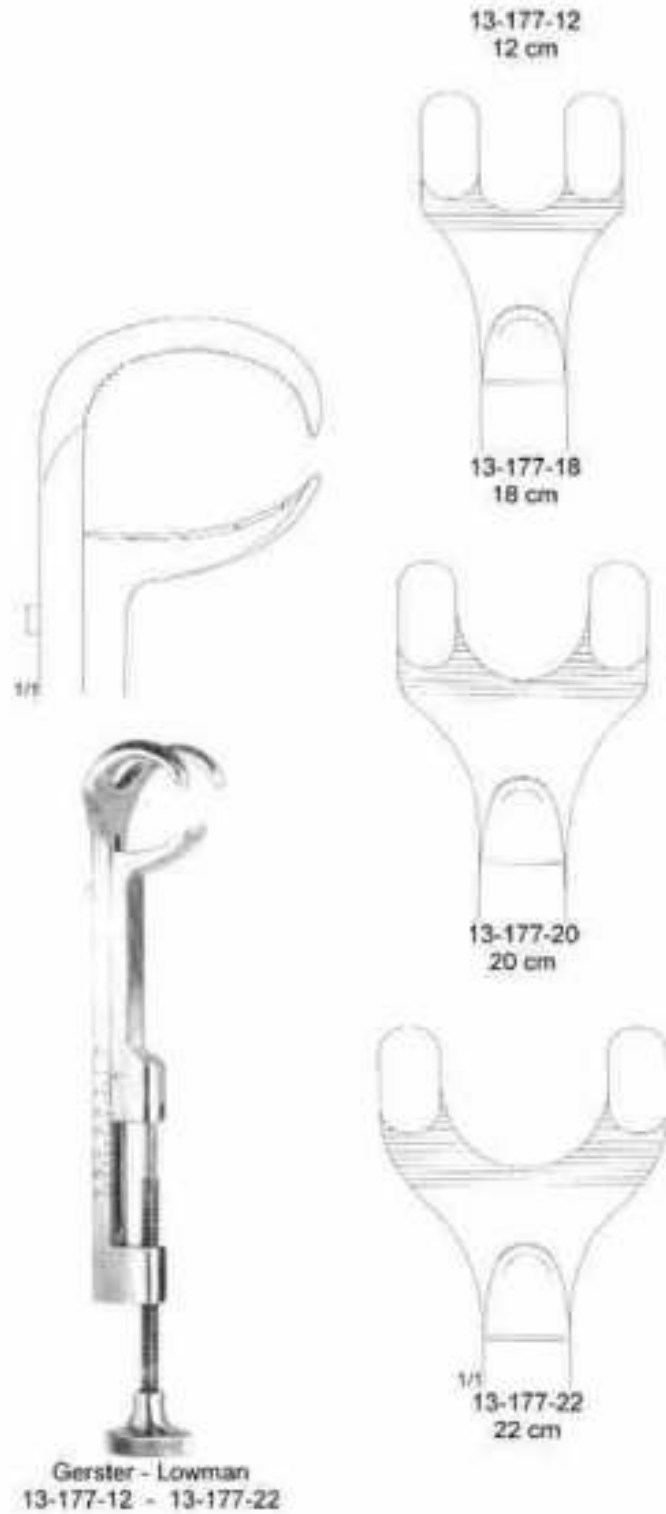



Bone Surgery - Knochenchirurgie - Cirugia ósea
Bone Holding Clamps
Knochenhalteklammern
Pinzas porta - huesos



Gerster
13-178-09
9 cm



Lowman - Baby
13-178-13
13 cm



Lowman - Hoglund
13-178-18 18 cm
13-178-20 20 cm
13-178-22 22 cm



Bunnell - Howard
13-179-15
15 cm



Lambert - Lowman
13-179-18 18 cm
13-179-20 20 cm
13-179-22 22 cm

Bone Surgery - Knochenchirurgie - Cirugía ósea
Hand Drills
Handbohrapparate
Perforadores de mano

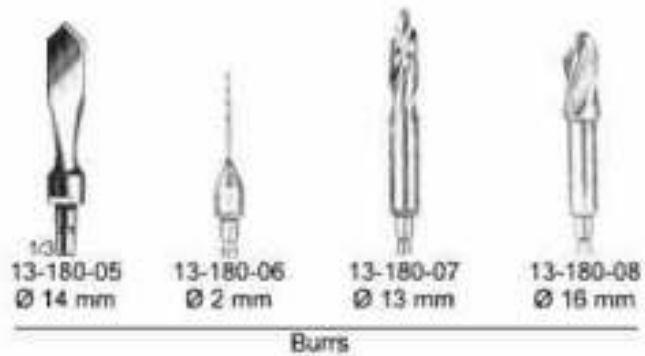

13-181-00 (Complete Set)
 13-181-01 (Brace, Extension With 4 Burs)

Bone Surgery - Knochenchirurgie - Cirugia ósea
Hand Drills
Handbohrapparate
Perforadores de mano



Raik
13-162-00



Bunnell
13-162-10



Bone Surgery - Knochenchirurgie - Cirugia ósea
Hand Drills
Handbohrapparate
Perforadores de mano



1/3
Stille - Sherman
13-184-24
24 cm

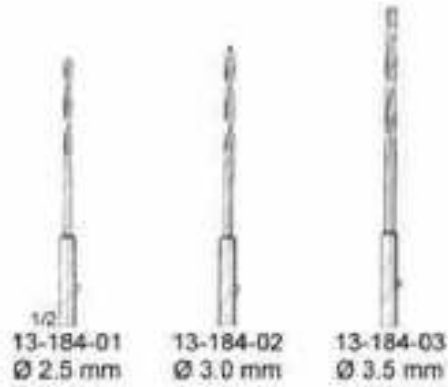

1/2
13-184-01 **13-184-02** **13-184-03**
Ø 2.5 mm **Ø 3.0 mm** **Ø 3.5 mm**

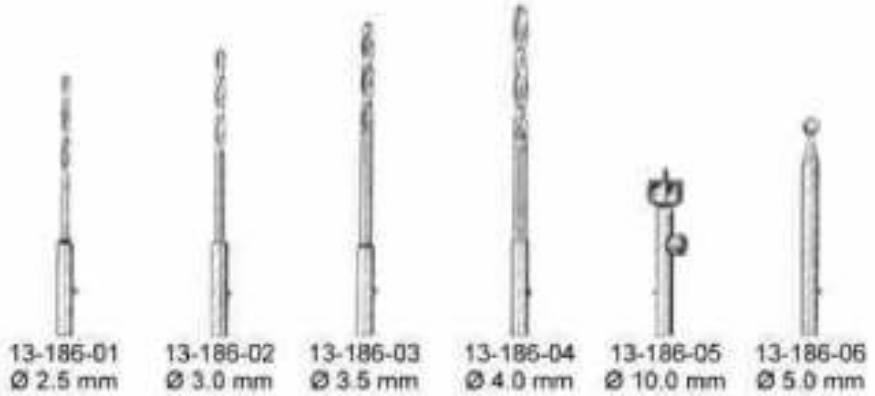

13-186-01 **13-186-02** **13-186-03** **13-186-04** **13-186-05** **13-186-06**
Ø 2.5 mm **Ø 3.0 mm** **Ø 3.5 mm** **Ø 4.0 mm** **Ø 10.0 mm** **Ø 5.0 mm**



1/3
Stille
13-186-20
20 cm

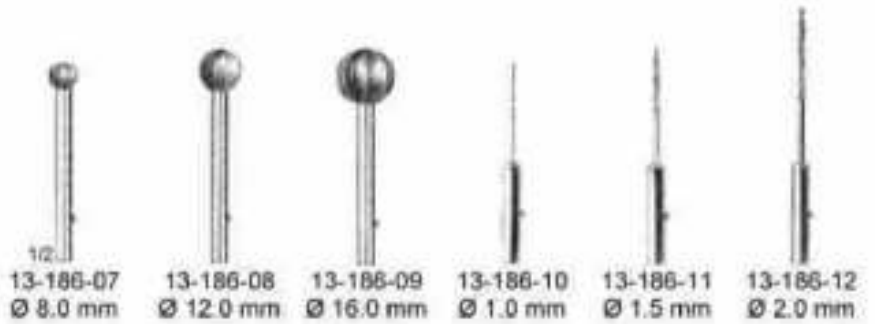

1/2
13-186-07 **13-186-08** **13-186-09** **13-186-10** **13-186-11** **13-186-12**
Ø 8.0 mm **Ø 12.0 mm** **Ø 16.0 mm** **Ø 1.0 mm** **Ø 1.5 mm** **Ø 2.0 mm**



Bone Surgery - Knochenchirurgie - Cirurgia ósea
Hand Drills
Handbohrapparate
Perforadores de mano



13-188-01



Handle with chuck

13-188-02

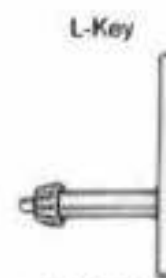

L-Key

13-188-03



Bone Surgery - Knochenchirurgie - Cirugia ósea
Wire Twisting Forceps
Draht - Zangen
Pinzas para trocer hilos





Bone Surgery - Knochenchirurgie - Cirugia ósea
Wire Twisting Forceps
Draht - Zangen
Pinzas para trocer hilos



Bone Surgery - Knochenchirurgie - Cirugia ósea
Wire Twisting Forceps
Draht - Zangen
Pinzas para trocer hilos



13-198-15
15 cm



13-200-17
17 cm



Baumgartner
13-202-20
20 cm

Bone Surgery - Knochenchirurgie - Cirugia ósea
Flat Nose Pliers, Wire Cutting Pliers
Flachzangen, Draht - Kneifzangen
Alicates planos, Alicates para cortar alambre

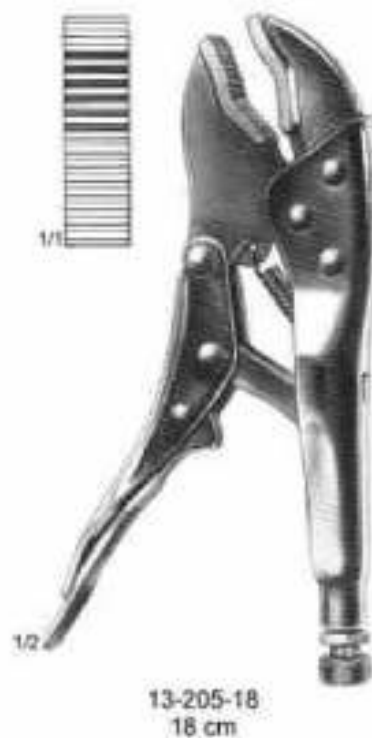

for bending and cutting





Bone Surgery - Knochenchirurgie - Cirugia ósea
Flat Nose Pliers
Flachzangen
Alicates Planas

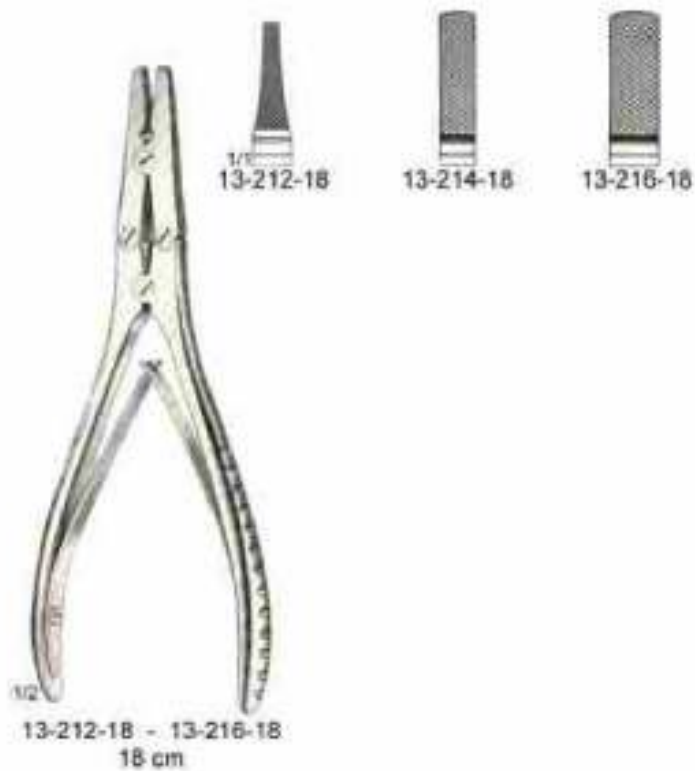
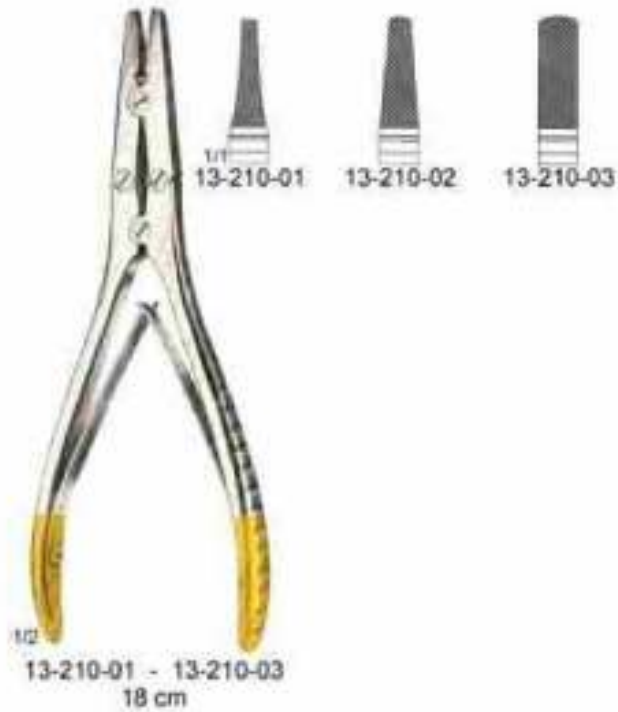



Bone Surgery - Knochenchirurgie - Cirugia ósea
Flat Nose Pliers
Flachzangen
Alicates Planas

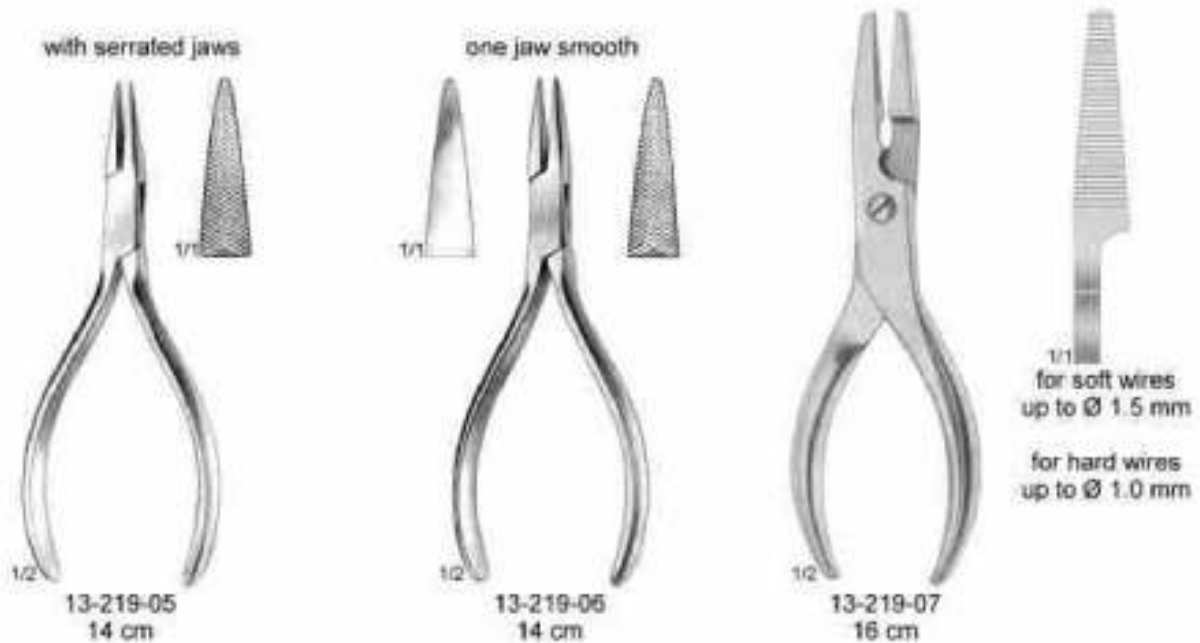
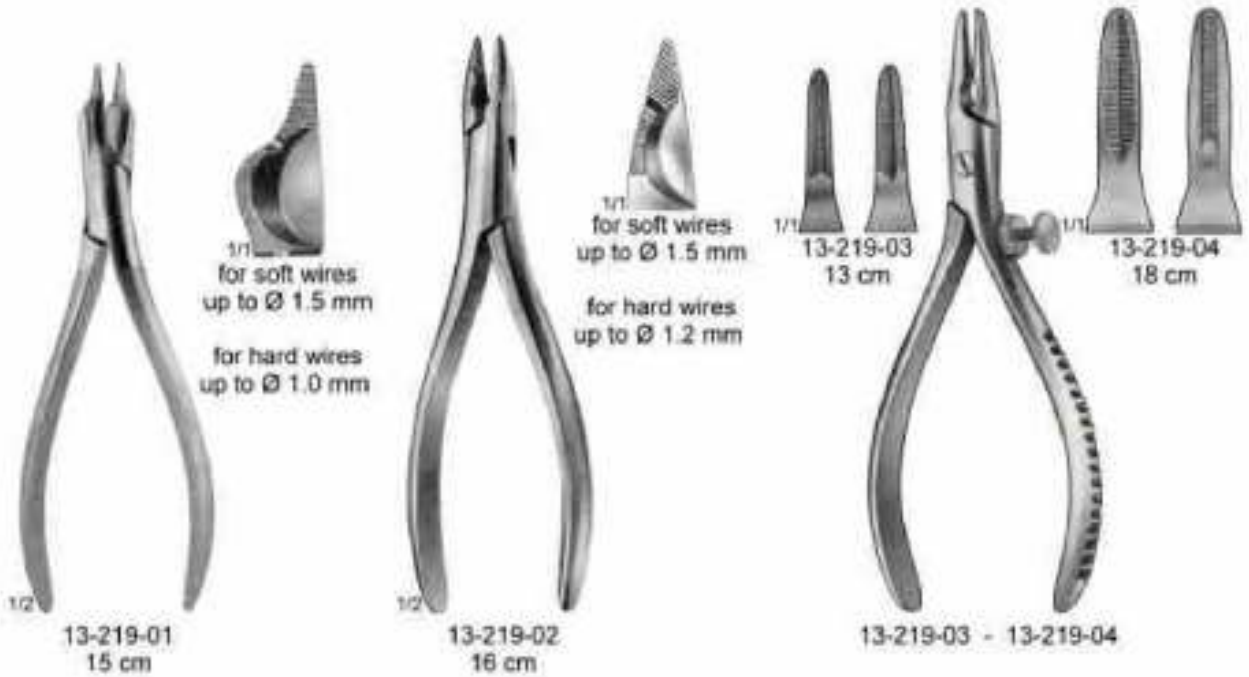



Bone Surgery - Knochenchirurgie - Cirugia ósea
Flat Nose Pliers
Flachzangen
Alicates Planas

with longitudinal groove



Hackstock
13-220-16
16 cm

with crosswise groove

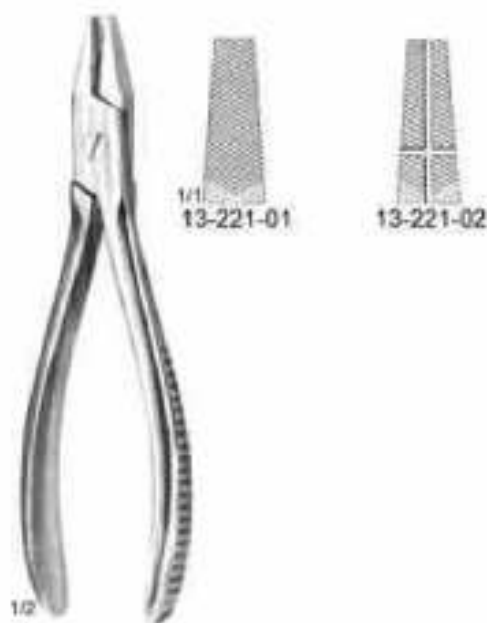

13-221-01 - 13-221-02
17 cm

pointed



13-221-03
19 cm

Bone Surgery - Knochenchirurgie - Cirugia ósea
Wire Cutting Pliers
Draht - Kneifzangen
Alicates para cortar alambre

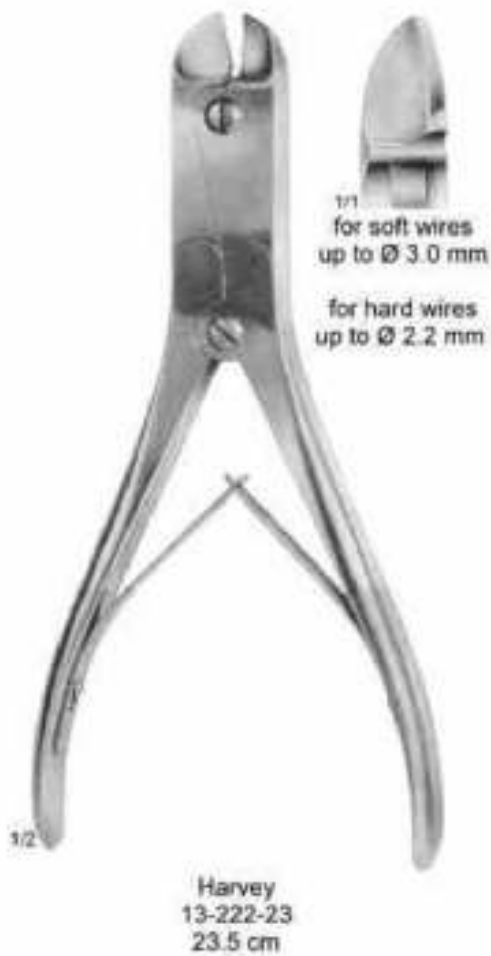



Bone Surgery - Knochenchirurgie - Cirugia ósea
Wire Cutting Pliers
Draht - Kneifzangen
Alicates para cortar alambre



1/1
for soft wires
up to \varnothing 0.5 mm
for hard wires
up to \varnothing 0.3 mm



1/1
for soft wires
up to \varnothing 1.5 mm
for hard wires
up to \varnothing 1.0 mm



1/1
for soft wires
up to \varnothing 2.0 mm
for hard wires
up to \varnothing 1.7 mm



for soft wires
up to \varnothing 2.0 mm
for hard wires
up to \varnothing 1.6 mm



for soft wires
up to \varnothing 3.0 mm
for hard wires
up to \varnothing 3.0 mm
Cutter for cutting off
Kirschner wires. Titrus
head screws, bolts, pin
up to \varnothing 3mm

Bone Surgery - Knochenchirurgie - Cirugia ósea
Wire Cutting Pliers
Draht - Kneifzangen
Alicates para cortar alambre



for soft wires
up to Ø 2.4 mm

for hard wires
up to Ø 1.8 mm

1/2

13-230-16
16 cm



for soft wires
up to Ø 2.2 mm

for hard wires
up to Ø 2.0 mm

1/2

Martin - Diamant
13-232-16
16 cm



1/1
for soft wires
up to Ø 1.5 mm

for hard wires
up to Ø 1.0 mm

1/2

13-233-14
14.5 cm



for soft wires
up to Ø 2.0 mm

for hard wires
up to Ø 1.2 mm

1/2

13-234-15
15 cm

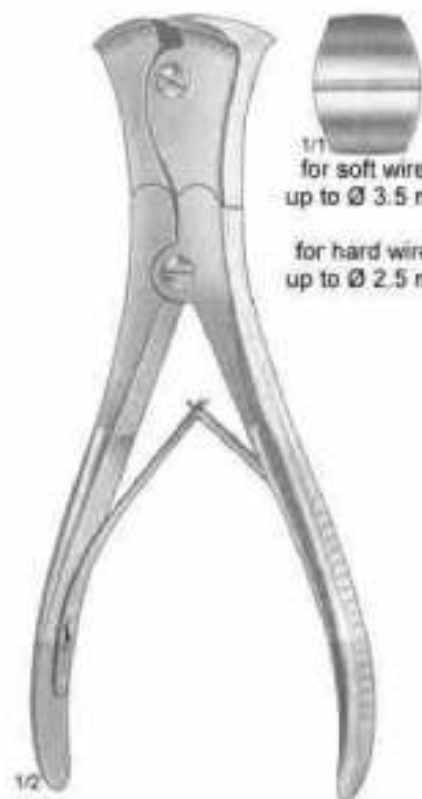

1/1
for soft wires
up to Ø 3.5 mm

for hard wires
up to Ø 2.5 mm

1/2

13-234-22
22 cm



Bone Surgery - Knochenchirurgie - Cirugía ósea
Wire Cutting Pliers
Draht - Kneifzangen
Alicates para cortar alambre

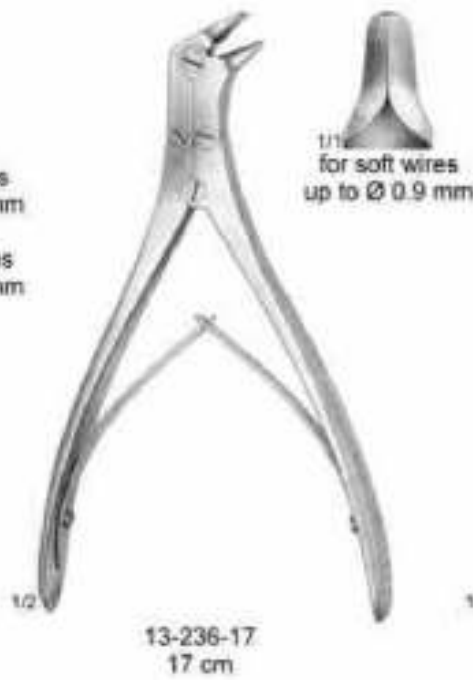
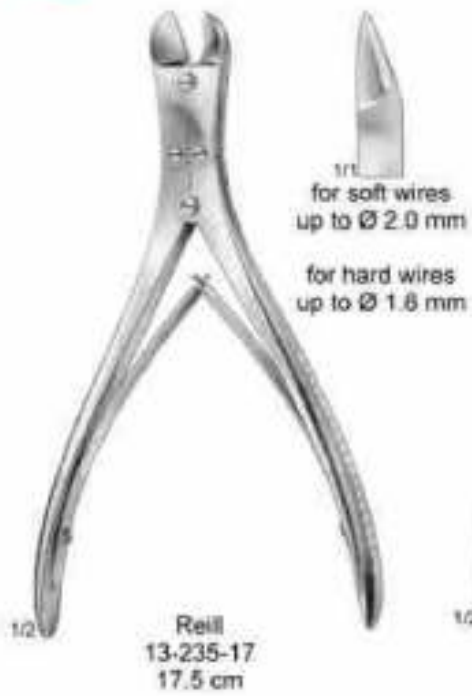



Bone Surgery - Knochenchirurgie - Cirugia ósea
Bone Wire Guides, Bone Wire Tighteners
Drahtumführungsnaedeln, Drahtspanninstrumente
Agujas pasa-hilos, Tensores cierra-hilo

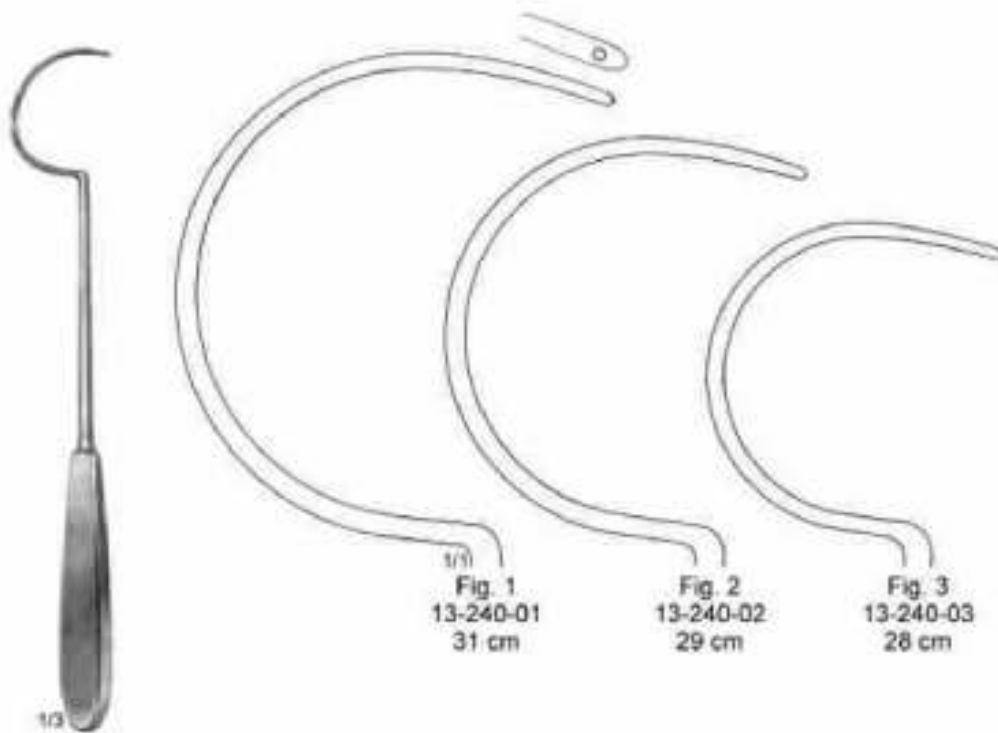

Fig 1
13-240-01
31 cm

Fig 2
13-240-02
29 cm

Fig 3
13-240-03
28 cm



13
Demel
13-240-01 - 13-240-03



12
Louie
13-242-21
21 cm



Bone Surgery - Knochenchirurgie - Cirugia ósea
Bone Wire Guides, Bone Wire Tighteners
Drahtumföhrungsnadeln, Drahtspanninstrumente
Agujas pasa-hilos, Tensores cierra-hilo



Demel
13-244-28
28 cm



Parham
13-246-23
23 cm



Parham
13-246-22
22 cm

Handle from artificial wood



13-248-45



13-248-70



Bone Surgery - Knochenchirurgie - Cirugia ósea
Extension Bows, Steinmann Pins, Clips
Extensionsbügel, Steinmann Nägel, Klammern
Extribos para extensión, Grapas

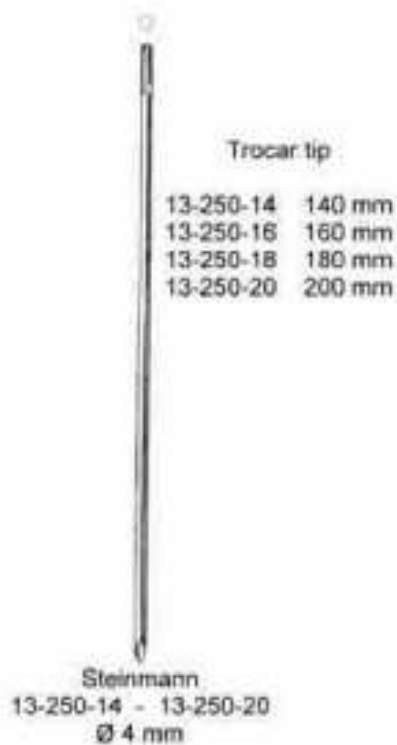

| cm | | |
|---------|-----------|--------------------|
| h x b | | |
| 16 x 9 | 13-255-16 | for arm |
| 21 x 11 | 13-255-21 | for thigh and knee |
| 21 x 15 | 13-255-15 | for femur and knee |

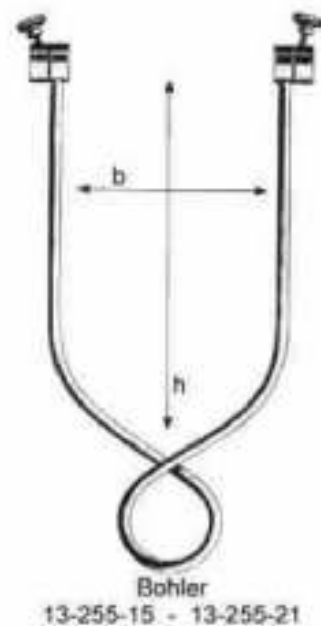

Bone Surgery - Knochenchirurgie - Cirurgia ósea
Extension Bows
Extensionsbügel
Extrijos para extensión

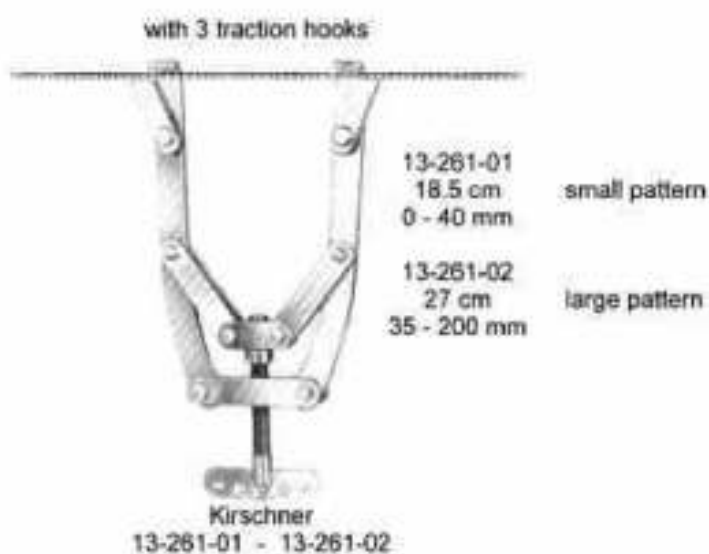

13-263-18 18 x 10 cm
13-263-27 27 x 16 cm

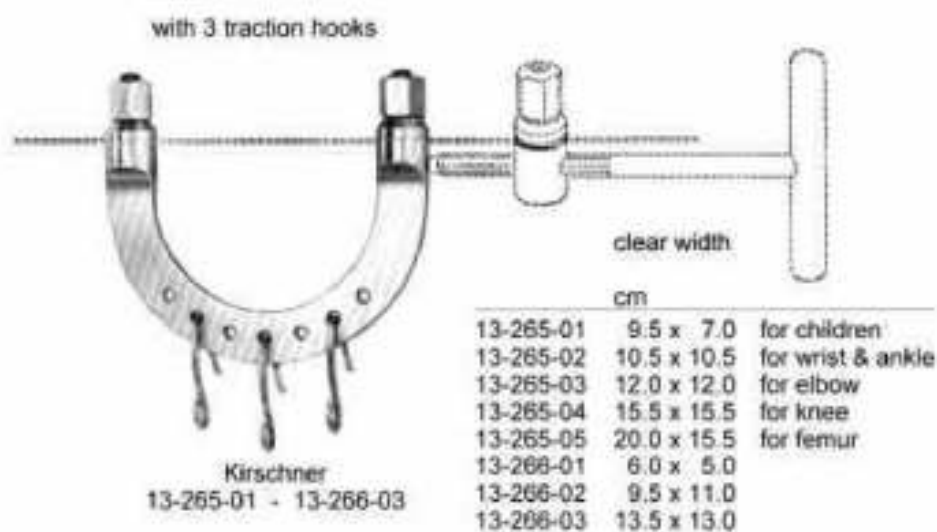

for extension bow



1/1
Traction Hook
13-267-03



1/1
Traction Hook
13-267-06



Bone Surgery - Knochenchirurgie - Cirugia ósea
Bone Chisels and Gouges
Meißel und Osteotome
Cinceles y Gubias para huesos

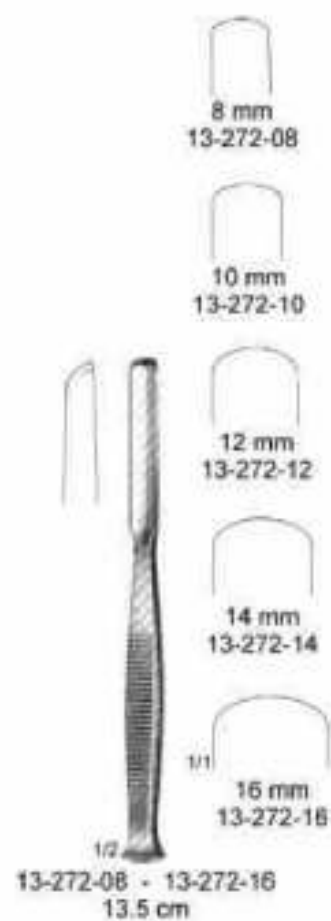
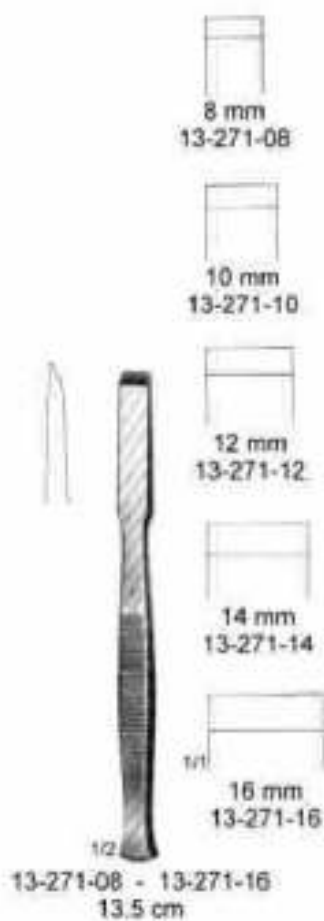
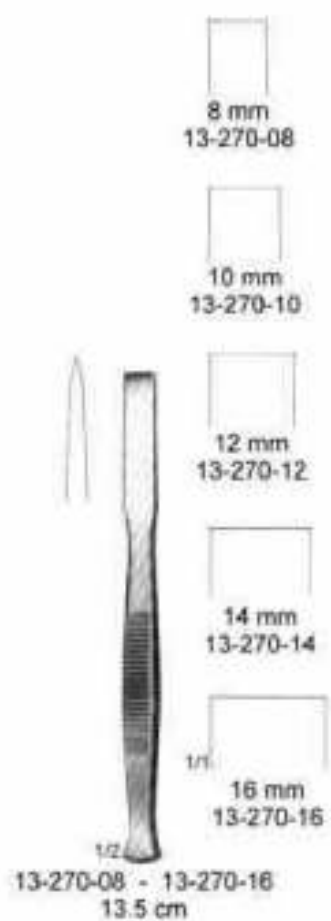



Bone Surgery - Knochenchirurgie - Cirugia ósea
Bone Chisels and Gouges
Meißel und Osteotome
Cinceles y Gubias para huesos

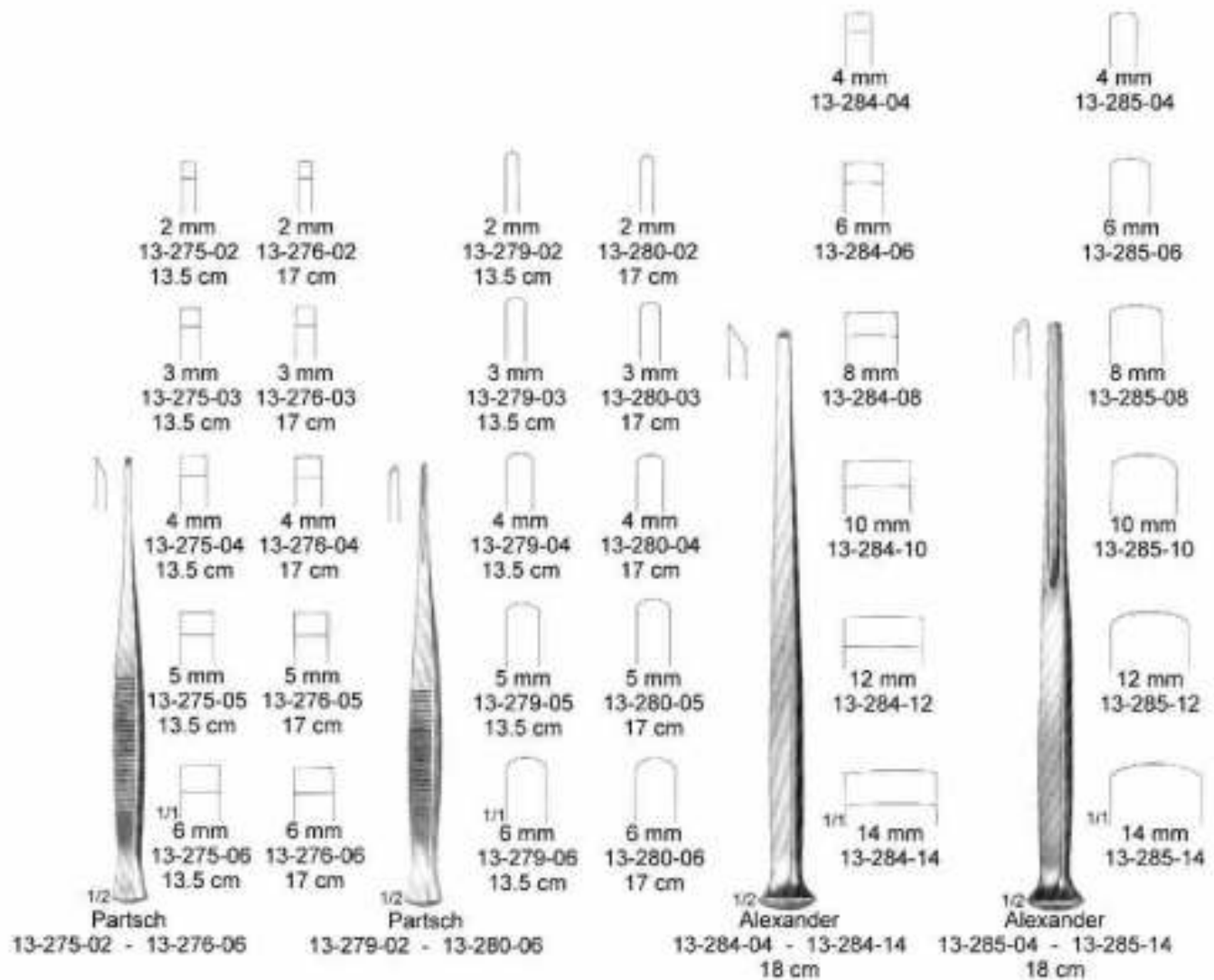



Bone Surgery - Knochenchirurgie - Cirugia ósea
Bone Chisels and Gouges
Meißel und Osteotome
Cinceles y Gubias para huesos

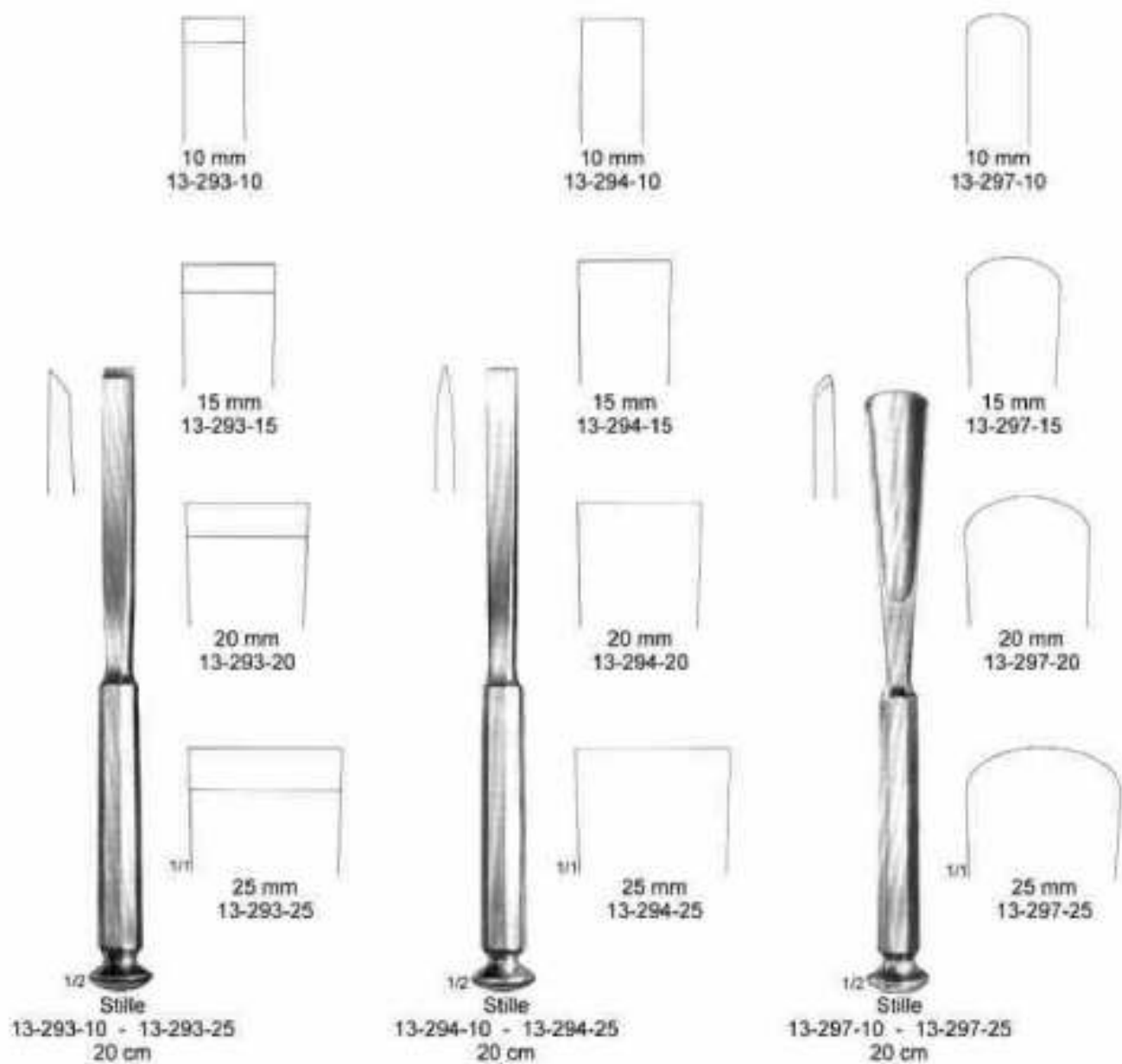



Bone Surgery - Knochenchirurgie - Cirugia ósea
Bone Chisels and Gouges
Meißel und Osteotome
Cinceles y Gubias para huesos

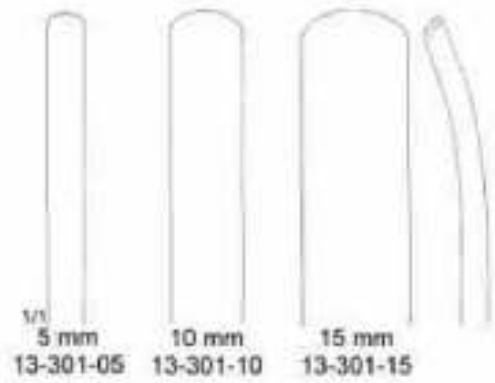
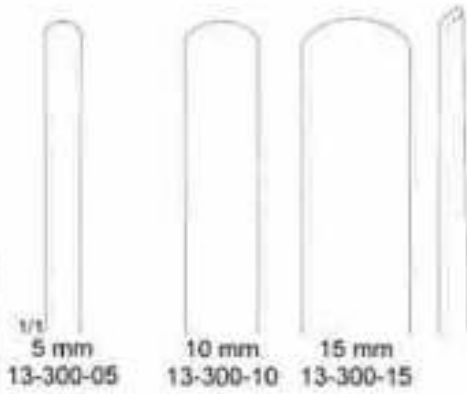

1/2
Lexer
13-300-05 - 13-300-15
25 cm

Handle from artificial wood



1/2
Lexer
13-301-05 - 13-301-15
25 cm

Handle from artificial wood



Bone Surgery - Knochenchirurgie - Cirugia ósea
Bone Chisels and Gouges
Meißel und Osteotome
Cinceles y Gubias para huesos

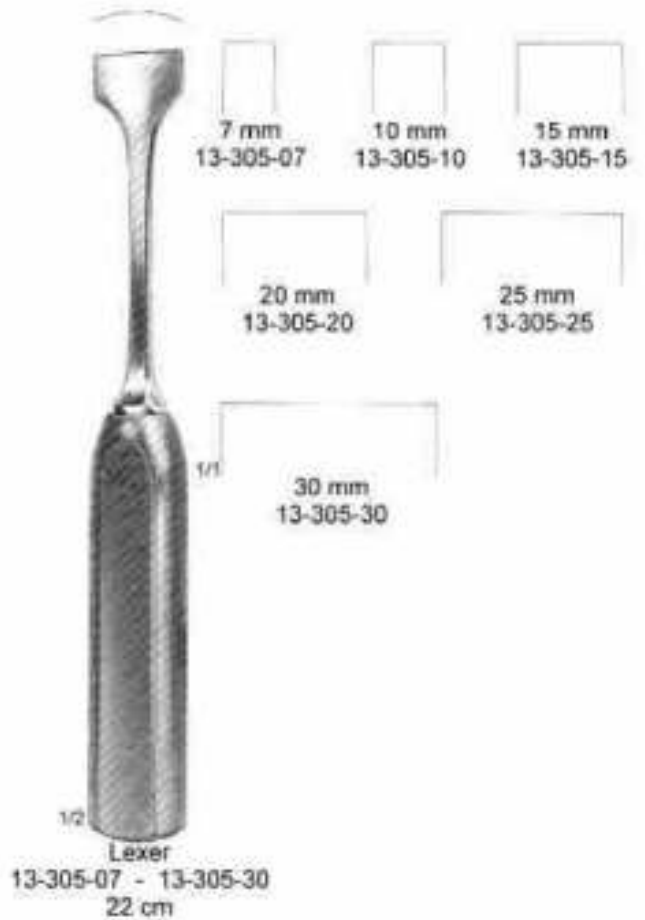
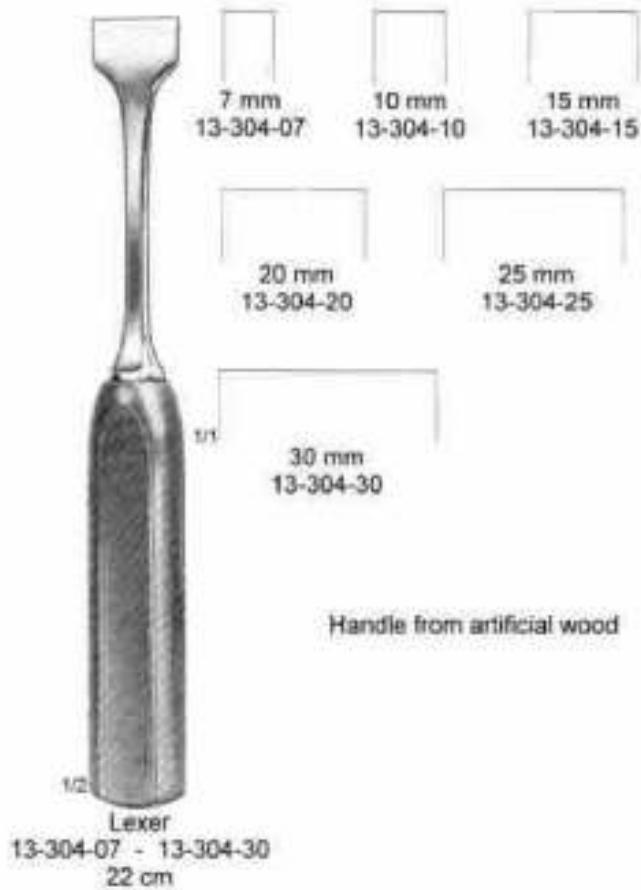
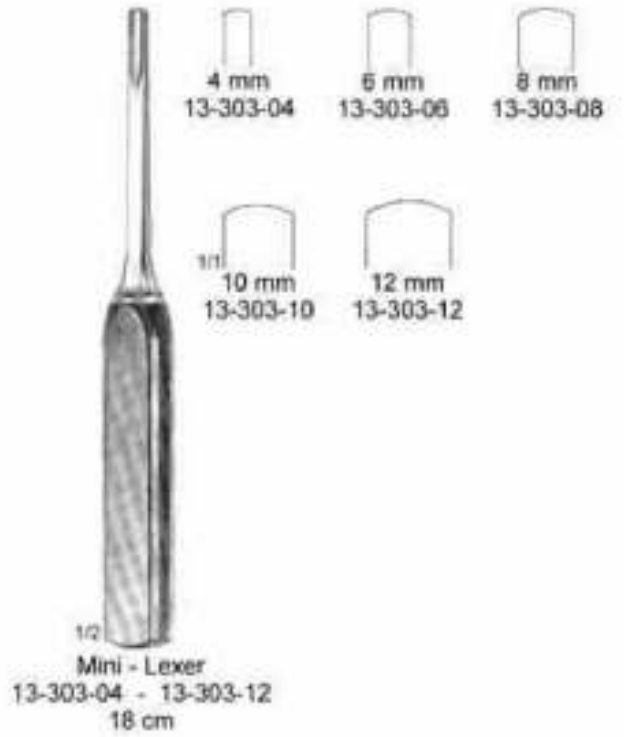
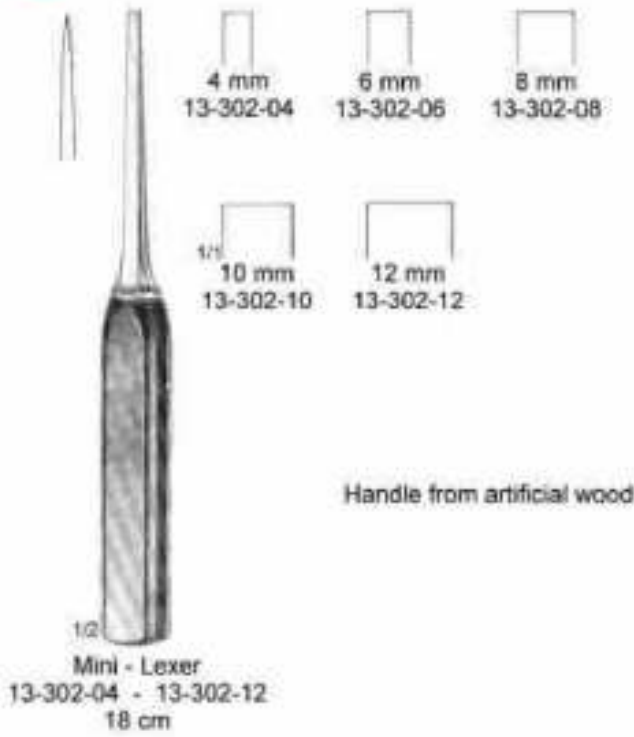



Bone Surgery - Knochenchirurgie - Cirugía ósea
Bone Chisels and Gouges
Meißel und Osteotome
Cinceles y Gubias para huesos



Handle from artificial wood

1/2

1/2

Lexer
27.5 cm

Lexer
27.5 cm

10 mm 13-306-10
15 mm 13-306-15

13-307-10
13-307-15



Bone Surgery - Knochenchirurgie - Cirugia ósea
Bone Chisels and Gouges
Meißel und Osteotome
Cinceles y Gubias para huesos

Handle of artificial wood



1/2
Cobb
13-310-01
28 cm



1/2
Cobb
13-310-02
28 cm



1/2
Cobb
13-310-03
28 cm



1/2
Cobb
13-310-04
28 cm



Bone Surgery - Knochenchirurgie - Cirugia ósea
Bone Chisels and Gouges
Meißel und Osteotome
Cinceles y Gubias para huesos

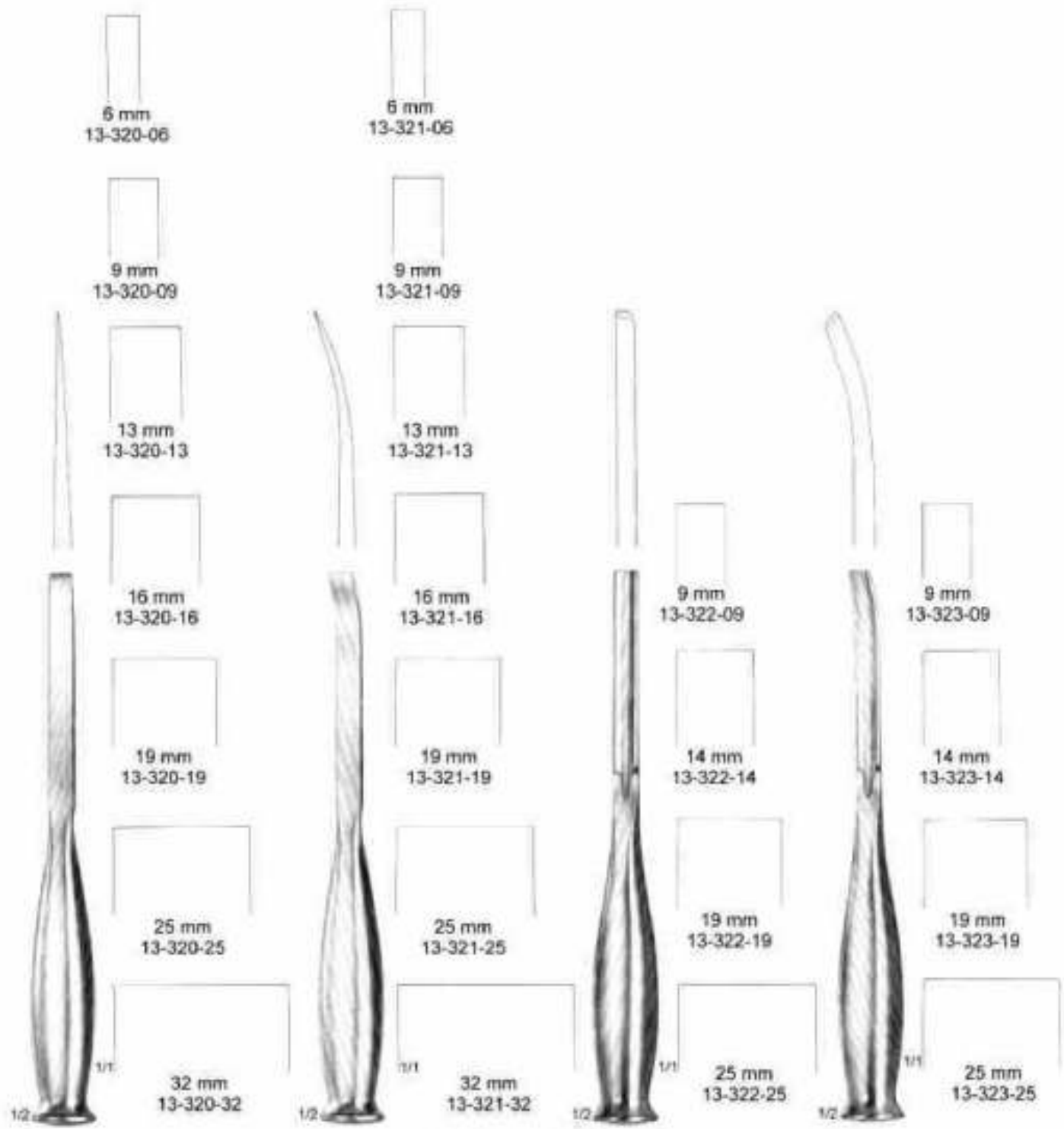

Smith - Petersen
 13-320-06 - 13-323-25
 20 cm



Bone Surgery - Knochenchirurgie - Cirugía ósea
Bone Chisels and Gouges
Meißel und Osteotome
Cinceles y Gubias para huesos

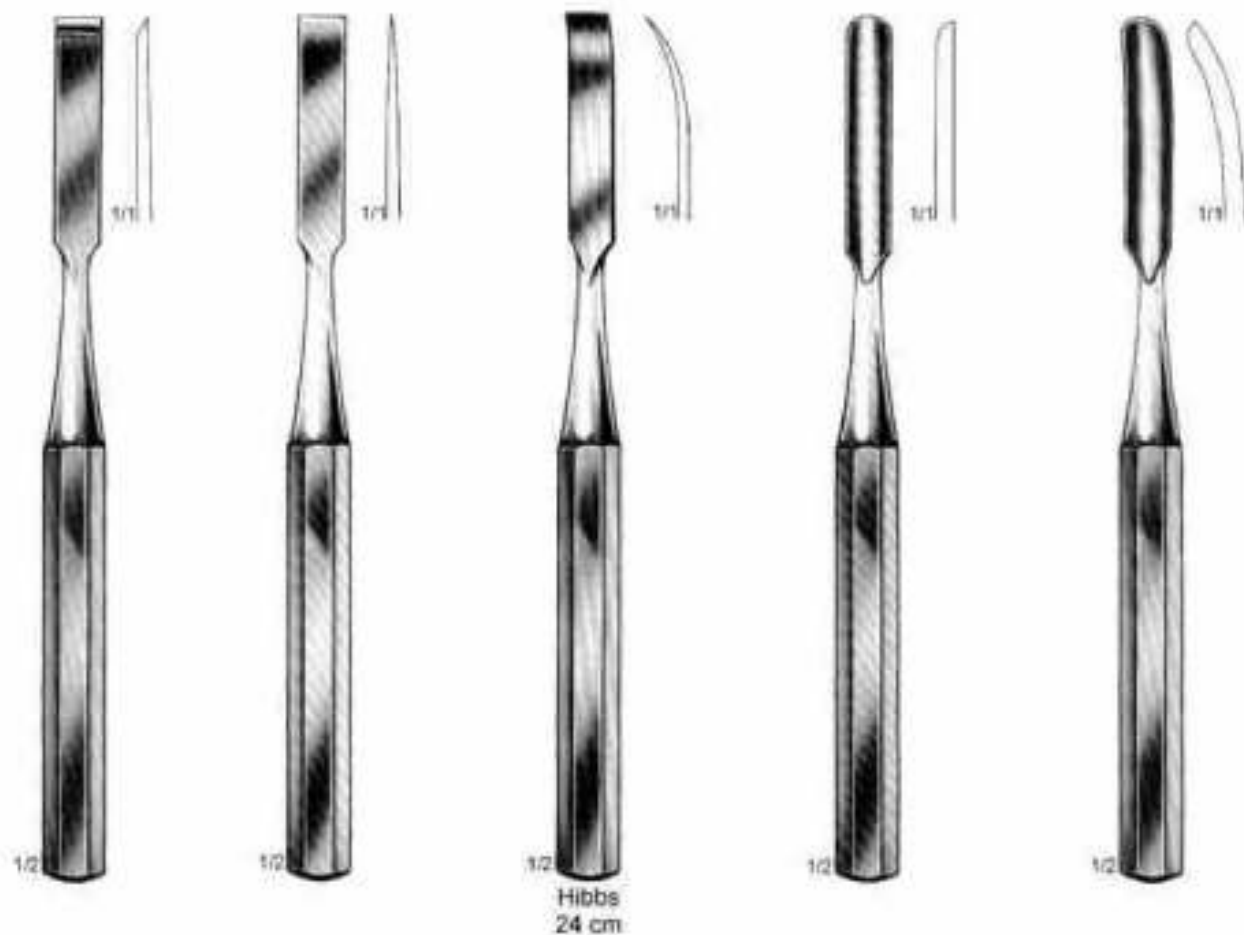

06 mm 13-333-06
 13 mm 13-333-13
 19 mm 13-333-19
 25 mm 13-333-25
 32 mm 13-333-32

13-334-06
 13-334-13
 13-334-19
 13-334-25
 13-334-32

13-335-06
 13-335-13
 13-335-19
 13-335-25
 13-335-32

13-336-06
 13-336-13
 13-336-19
 13-336-25
 13-336-32

13-337-06
 13-337-13
 13-337-19
 13-337-25
 13-337-32



Bone Surgery - Knochenchirurgie - Cirugia ósea
Bone Chisels and Gouges
Meißel und Osteotome
Cinceles y Gubias para huesos

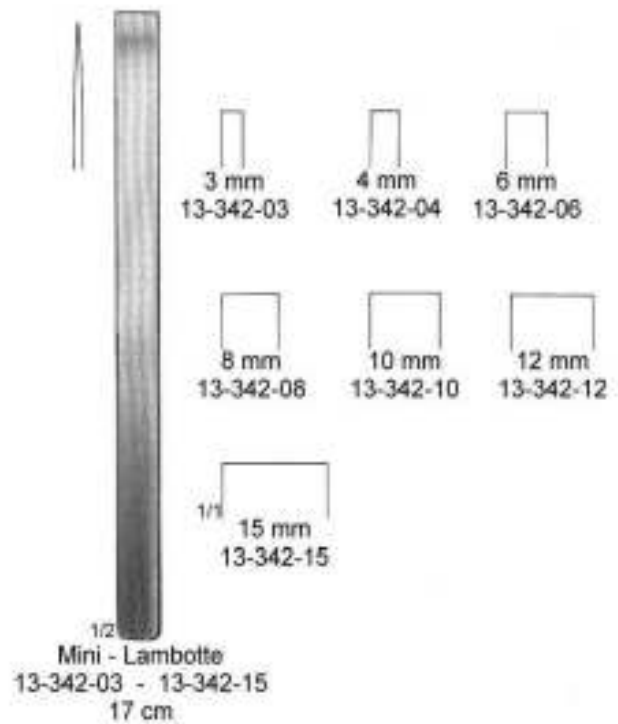
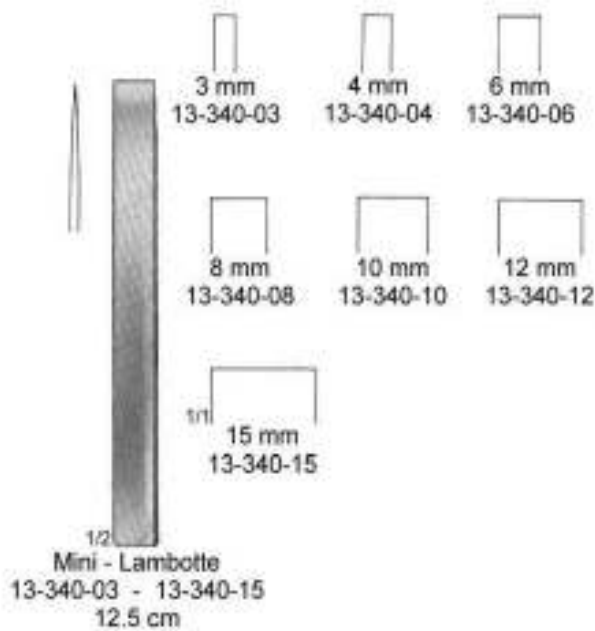



Bone Surgery - Knochenchirurgie - Cirugía ósea
 Bone Chisels and Gouges
 Meißel und Osteotome
 Cinceles y Gubias para huesos

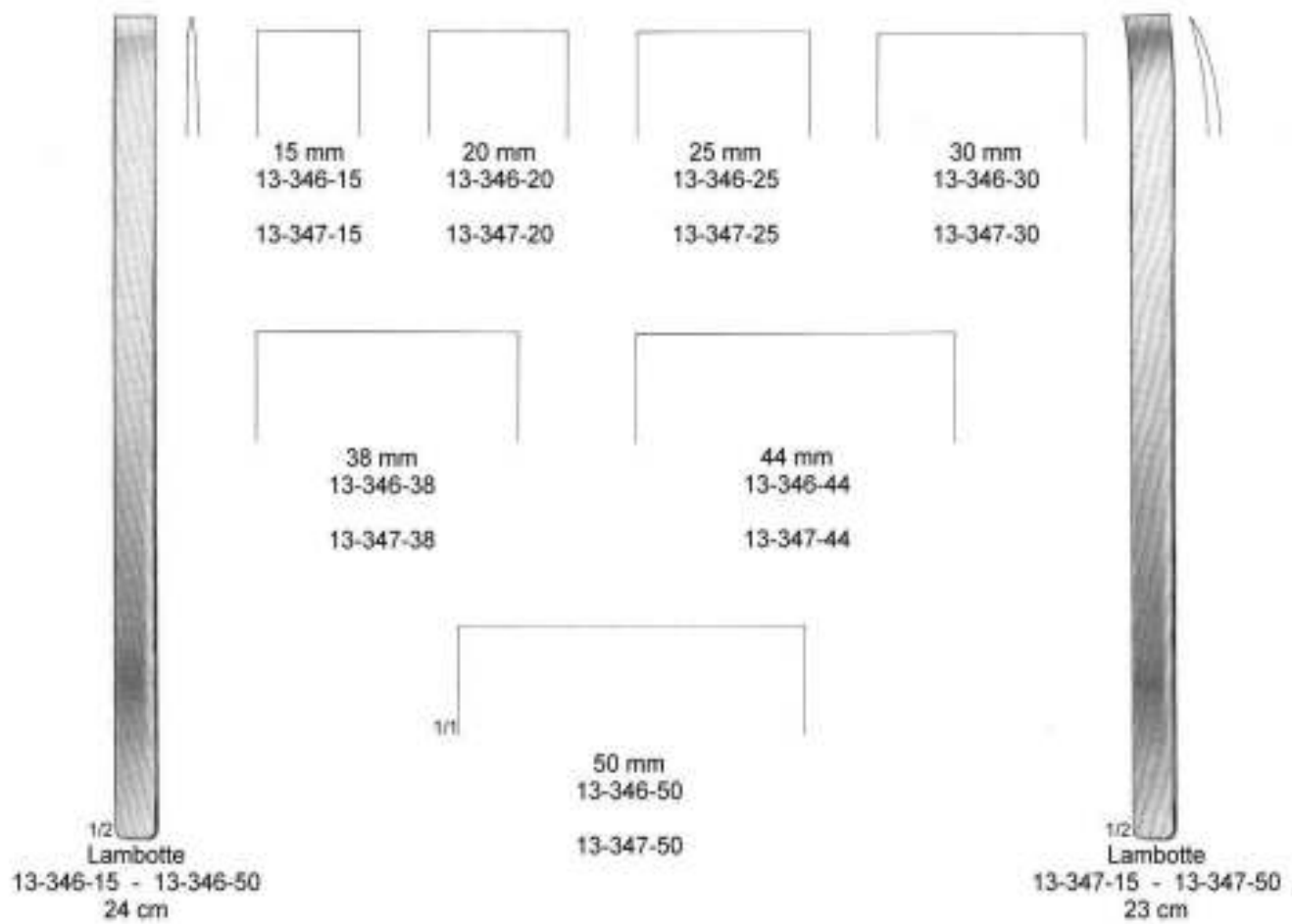



Bone Surgery - Knochenchirurgie - Cirugía ósea
 Bone Chisels and Gouges, Bone Rasp
 Meißel und Osteotome, Knochenra Speln
 Cinceles y Gubias para huesos, Escofinas para Hueso





Bone Surgery - Knochenchirurgie - Cirugía ósea
Lead Hands, Nail Instruments
Bleihände, Instrumente für Finger- und Zehennägel
Manoplas de plomo, Instrumentos para uñas



13-360-01
Child Size

13-360-02
Adult Size

1/2

13-360-01 - 13-360-02



1/2
Feldheim
13-366-10
10 cm



1/2
Ideal
13-370-10

13-371-00 (13-371-01 + 13-371-02 + 13-371-03 + 13-370-10)



1/1
13-371-01



13-371-02



13-371-03



Bone Surgery - Knochenchirurgie - Cirugia ósea
Mallets
Hämmer
Martillos y Mazos



300 g
(10 3/4 oz.)

1/2
Bergmann
13-400-24
24 cm

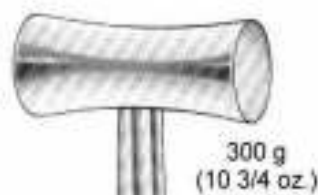

300 g
(10 3/4 oz.)

1/2
Bergmann
13-402-23
23 cm

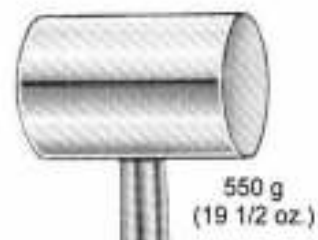

550 g
(19 1/2 oz.)

1/2
Ombredanne
13-404-24
24 cm



Bone Surgery - Knochenchirurgie - Cirugía ósea
 Mallets
 Hämmer
 Martillos y Mazos



13-406-01
 Ø 26 mm
 300 g (10 1/2 oz.)

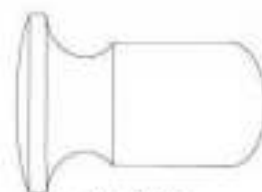

13-408-01
 Ø 25 mm
 120 g (4 1/2 oz.)



13-406-02
 Ø 28 mm
 340 g (12 oz.)

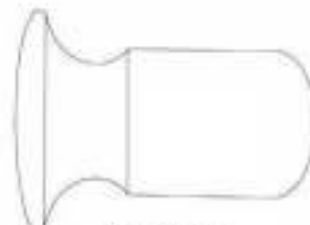

13-408-02
 Ø 30 mm
 180 g (6 1/2 oz.)



13-406-03
 Ø 30 mm
 400 g (14 oz.)

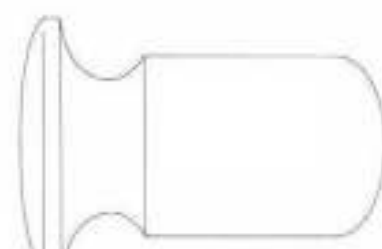

13-408-03
 Ø 35 mm
 260 g (9 oz.)

1/2
 Williger
 13-406-01 - 13-406-03
 24 cm

(lead filled)

1/2
 Doyen
 13-408-01 20.5 cm
 13-408-02 21.0 cm
 13-408-03 21.5 cm



Bone Surgery - Knochenchirurgie - Cirugía ósea
 Mallets
 Hämmer
 Martillos y Mazos

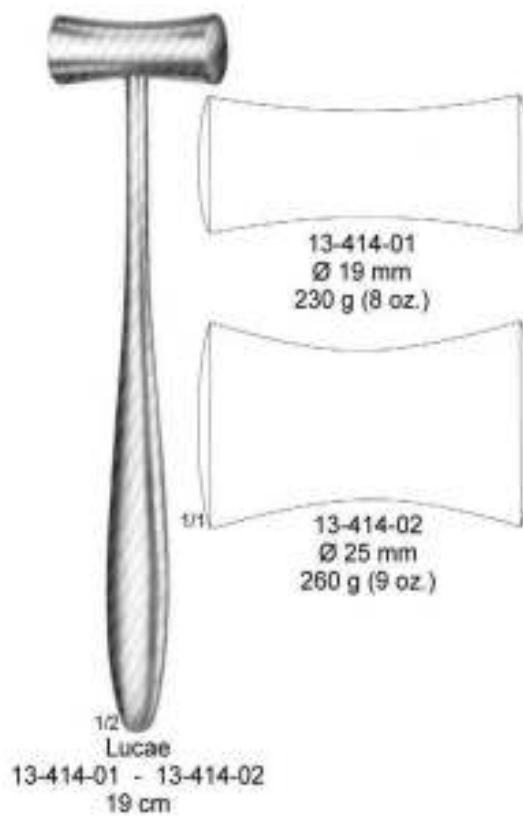



Bone Surgery - Knochenchirurgie - Cirugia ósea
Mallets
Hämmer
Martillos y Mazos





Bone Surgery - Knochenchirurgie - Cirugía ósea
Mallets
Hämmer
Martillos y Mazos

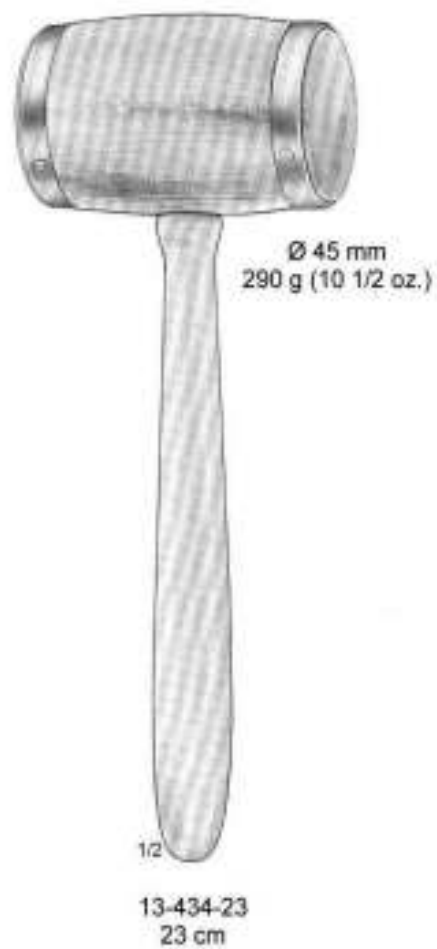
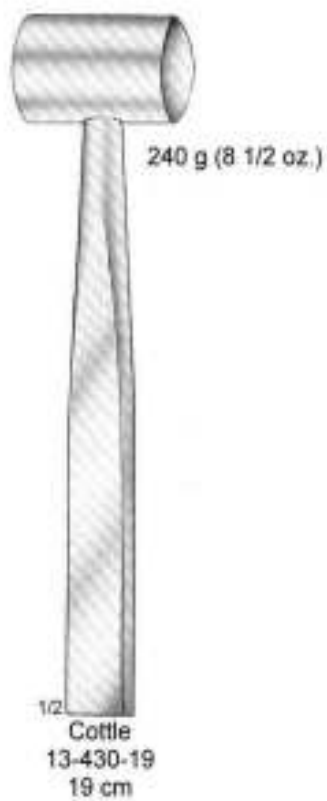



Bone Surgery - Knochenchirurgie - Cirugia ósea
Mallets
Hämmer
Martillos y Mazos

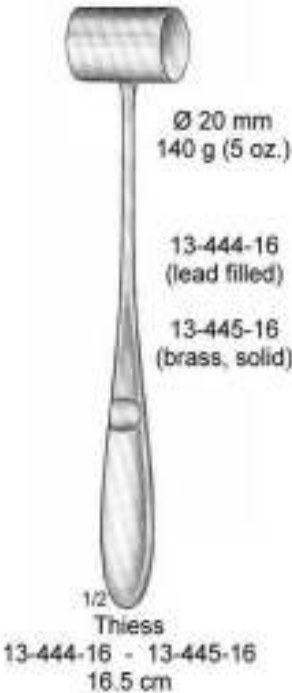
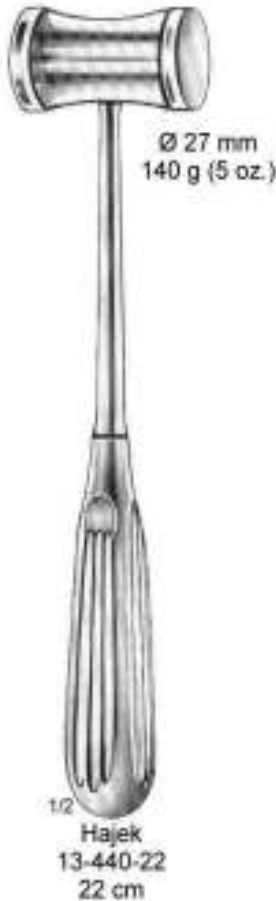



Bone Surgery - Knochenchirurgie - Cirugía ósea
Mallets
Hämmer
Martillos y Mazos



Ø 30 mm
510 g (18 oz.)

1/2

13-448-26
26 cm

with interchangeable
Ferozell faces

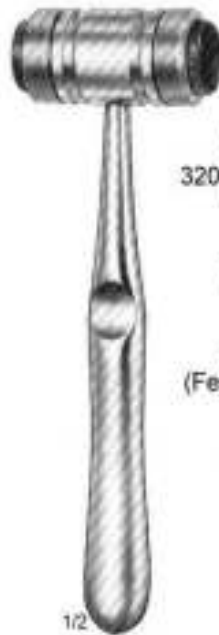

Ø 26 mm
320 g (11 1/4 oz.)

13-450-17
(solid)

13-451-17
(Ferozell Faces)

1/2

Mead
13-450-17 - 13-451-17
17 cm



Ø 22 mm
200 g (7 oz.)

1/2

Partsch
13-454-18
18 cm



Bone Surgery - Knochenchirurgie - Cirugía ósea
Mallets
Hämmer
Martillos y Mazos

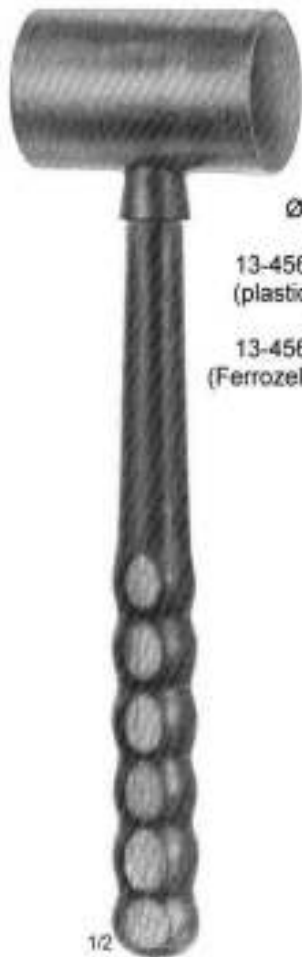

Ø 42 mm

13-456-01 250 g
(plastic, lead filled)

13-456-02 400 g
(Ferozell, without lead)

1/2
13-456-01 - 13-456-02
26 cm



Ø 42 mm
400 g

1/2
13-456-26
26 cm
(Ferozell, lead filled)



Ø 30 mm
675 g

1/2
13-460-26
26 cm
(repercussion free)



Bone Surgery - Knochenchirurgie - Cirugía ósea
 Mallets
 Hämmer
 Martillos y Mazos



Spare Faces, pair



(with plastic handle)



(with plastic handle)



(with Ferrozell faces)





Bone Surgery - Knochenchirurgie - Cirugía ósea
Mallets
Hämmer
Martillos y Mazos



Ø 30 mm
450 g

1/2

13-470-01
26 cm
(steel, solid)



Ø 50 mm
900 g

1/2

13-470-02
26 cm
(steel, solid)

with interchangeable plastic disks

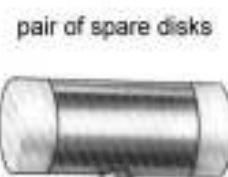

pair of spare disks

Ø 25 mm
300 g

1/2

Vickers
13-472-19
19 cm



Bone Surgery - Knochenchirurgie - Cirugia ósea
 Mallets
 Hämmer
 Martillos y Mazos





Bone Surgery - Knochenchirurgie - Cirugía ósea
 Bone Currettes
 Scharfe Löffel
 Cucharillas cortantes

Handle from artificial wood

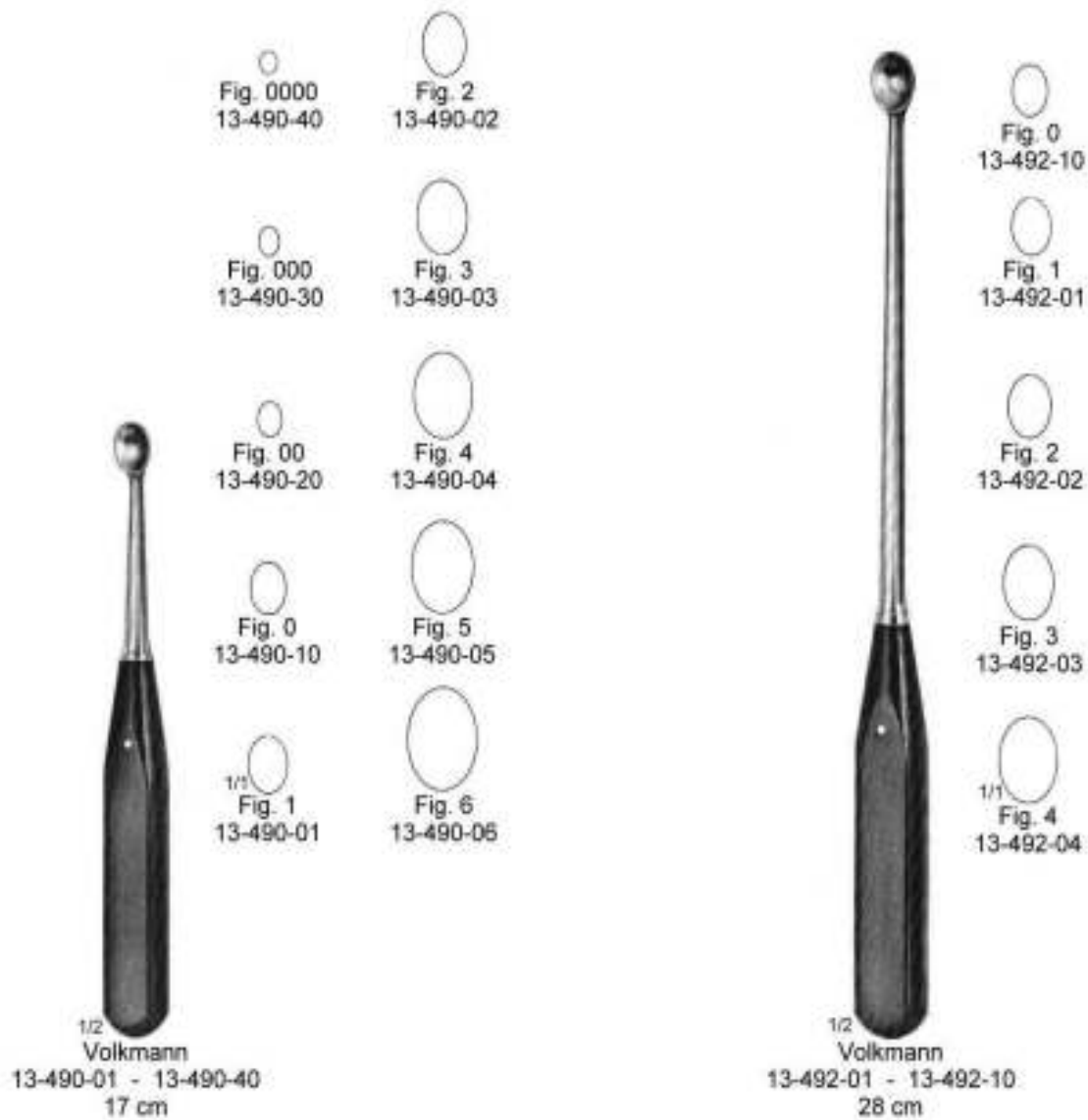



Bone Surgery - Knochenchirurgie - Cirugía ósea
Bone Currettes
Scharfe Löffel
Cucharillas cortantes

Fig. 000 13-500-30
Fig. 00 13-500-20
Fig. 0 13-500-10

Fig. 0000 13-502-40
Fig. 000 13-502-30
Fig. 00 13-502-20

Fig. 1 13-501-01
Fig. 2 13-501-02
Fig. 3 13-501-03

Fig. 0 13-502-10
Fig. 1 13-503-01
Fig. 2 13-503-02

1/1
Fig. 4
13-501-04

Fig. 3 13-503-03
Fig. 4 13-503-04
Fig. 5 13-503-05

1/1
Fig. 6
13-503-06



1/2
Schede
13-500-10 - 13-501-04
17 cm



1/2
Volkmann
13-502-10 - 13-503-06
17 cm



Bone Surgery - Knochenchirurgie - Cirugía ósea
Bone Currettes
Scharfe Löffel
Cucharillas cortantes

Fig. 0000 13-504-40
Fig. 000 13-504-30
Fig. 00 13-504-20

Fig. 0000 13-506-40
Fig. 000 13-506-30
Fig. 00 13-506-20

Fig. 0 13-504-10
Fig. 1 13-505-01
Fig. 2 13-505-02

Fig. 0 13-506-10
Fig. 1 13-507-01
Fig. 2 13-507-02

Fig. 3 13-505-03
Fig. 4 13-505-04
Fig. 5 13-505-05

Fig. 3 13-507-03
Fig. 4 13-507-04
Fig. 5 13-507-05

Fig. 6 13-505-06



1/2
Bruns
13-504-10 - 13-505-06
17 cm

1/2
Spratt
13-506-10 - 13-507-05
17 cm



Bone Surgery - Knochenchirurgie - Cirugía ósea
 Bone Currettes
 Scharfe Löffel
 Cucharillas cortantes

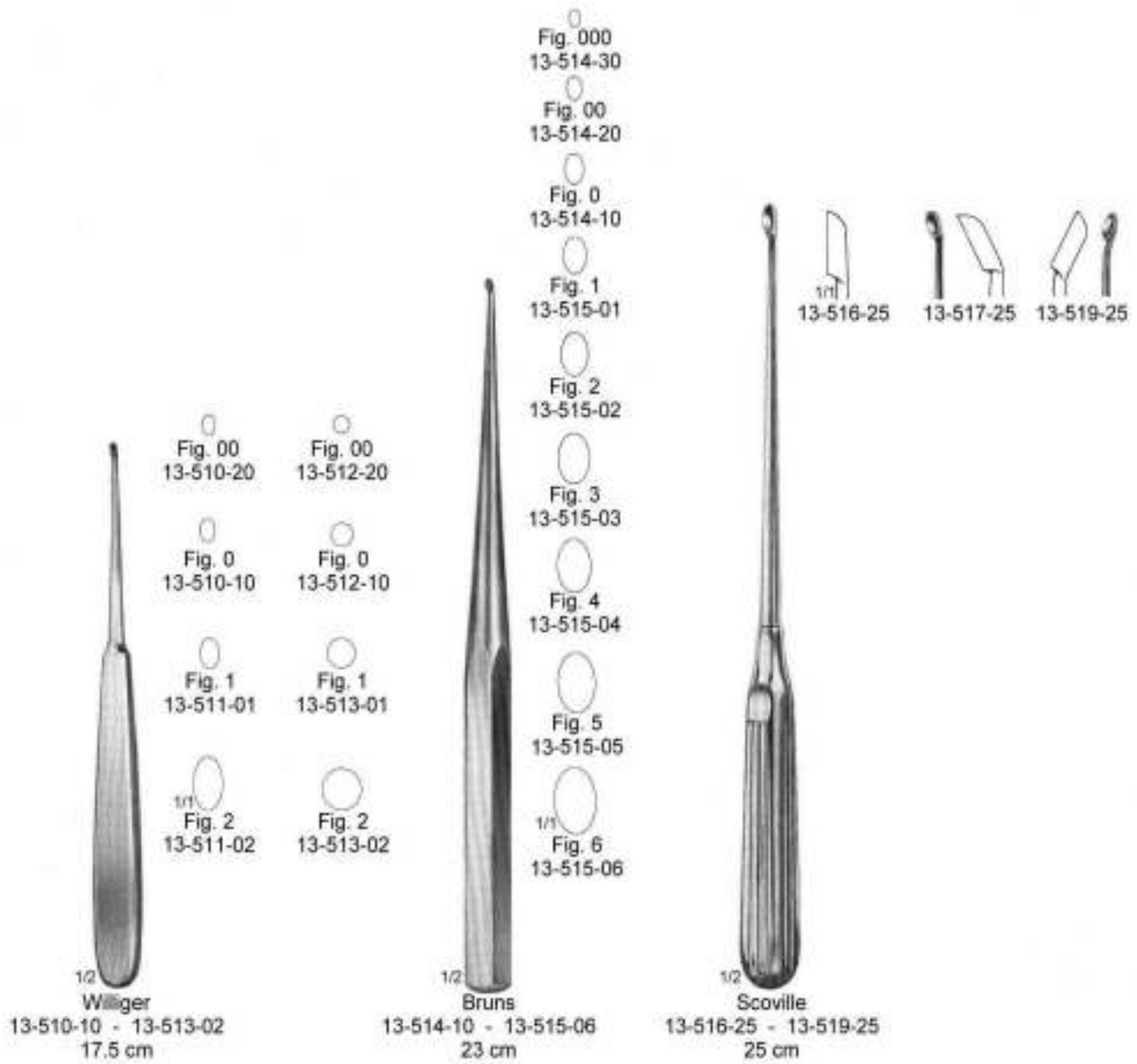



Bone Surgery - Knochenchirurgie - Cirugía ósea
 Bone Currettes
 Scharfe Löffel
 Cucharillas cortantes

Fig. 000
13-520-00

Fig. 3
13-524-03

Fig. 000
13-521-00

Fig. 3
13-525-03

Fig. 00
13-522-00

Fig. 4
13-524-04

Fig. 00
13-523-00

Fig. 4
13-525-04

Fig. 0
13-524-00

Fig. 5
13-524-05

Fig. 0
13-525-00

Fig. 5
13-525-05

Fig. 1
13-524-01

Fig. 6
13-524-06

Fig. 1
13-525-01

Fig. 6
13-525-06

1/1
Fig. 2
13-524-02

1/1
Fig. 2
13-525-02



1/2

Cloward Hibbs Spratt Spinal Fusion
 13-520-00 - 13-524-06
 22.5 cm



1/2

Cloward Hibbs Spratt Spinal Fusion
 13-521-00 - 13-525-06
 22.5 cm



Bone Surgery - Knochenchirurgie - Cirugia ósea
Bone Currettes
Scharfe Löffel
Cucharillas cortantes





Bone Surgery - Knochenchirurgie - Cirugía ósea
Bone Currettes
Scharfe Löffel
Cucharillas cortantes



13-530-00 - 13-530-03
25 cm

3.6 mm
13-530-00

4.4 mm
13-530-01

5.2 mm
13-530-02

6.0 mm
13-530-03



13-531-00 - 13-531-03
25 cm

3.6 mm
13-531-00

4.4 mm
13-531-01

5.2 mm
13-531-02

6.0 mm
13-531-03





Bone Surgery - Knochenchirurgie - Cirurgia ósea
 Bone Curettes
 Scharfe Löffel
 Cucharillas cortantes



 13-534-00
 3.0 x 5.0 mm



 13-536-00
 3.0 x 5.0 mm

 13-538-00
 4.06 x 5.08 mm

 13-534-01
 3.5 x 5.5 mm

 13-536-01
 3.5 x 5.5 mm

 13-538-01
 5.08 x 6.35 mm

 13-534-02
 4.5 x 6.4 mm

 13-536-02
 4.5 x 6.4 mm

 13-538-02
 6.10 x 7.62 mm

 13-534-03
 5.0 x 8.0 mm

 13-536-03
 5.0 x 8.0 mm

 13-538-03
 7.11 x 8.89 mm

 13-534-04
 6.0 x 9.0 mm

 13-536-04
 6.0 x 9.0 mm

 13-538-04
 8.13 x 10.16 mm

 13-534-05
 7.0 x 11.0 mm

 13-536-05
 7.0 x 11.0 mm

 13-538-05
 9.14 x 11.43 mm

 13-534-06
 8.5 x 12.5 mm

 13-536-06
 8.5 x 12.5 mm

 13-538-06
 10.16 x 12.70 mm

 13-534-07
 9.5 x 14.5 mm

 13-536-07
 9.5 x 14.5 mm

 13-538-07
 11.18 x 13.97 mm

 13-534-08
 10.5 x 16.8 mm

 13-536-08
 10.5 x 16.8 mm

 13-538-08
 12.19 x 15.24 mm



1/2 Hatfield
 13-534-00 - 13-534-08
 23 cm

1/2 Hatfield
 13-536-00 - 13-536-08
 28 cm

1/2 Cobb
 13-538-00 - 13-538-08
 28 cm















Bone Surgery - Knochenchirurgie - Cirugía ósea
 Bone Currettes
 Scharfe Löffel
 Cucharillas cortantes

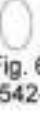

- Fig. 1
13-540-01
- Fig. 2
13-540-02
- Fig. 3
13-540-03
- Fig. 4
13-540-04
- Fig. 5
13-540-05
- 1/1 Fig. 6
13-540-06

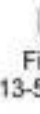
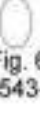
1/2
Simon
13-540-01 - 13-540-06
24 cm

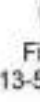
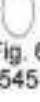

- | | | | | | |
|---|-------------------------|---|---------------------|---|---------------------|
|  | Fig. 1 13-542-01 |  | Fig. 2 13-542-02 |  | Fig. 3 13-542-03 |
|  | Fig. 4 13-542-04 |  | Fig. 5 13-542-05 |  | Fig. 6 13-542-06 |
|  | Fig. 1 13-543-01 |  | Fig. 2 13-543-02 |  | Fig. 3 13-543-03 |
|  | Fig. 4 13-543-04 |  | Fig. 5 13-543-05 |  | Fig. 6 13-543-06 |
|  | Fig. 1 13-545-01 |  | Fig. 2 13-545-02 |  | Fig. 3 13-545-03 |
|  | 1/1 Fig. 4 13-545-04 |  | Fig. 5 13-545-05 |  | Fig. 6 13-545-06 |

1/2
Mod. USA
13-542-01 - 13-545-06
16 cm



- flexible
- Fig. 1
13-548-01
 - Fig. 2
13-548-02
 - 1/1 Fig. 3
13-548-03

1/2
Halle
13-548-01 - 13-548-03
21 cm



Bone Surgery - Knochenchirurgie - Cirugia ósea
Bone Curettes
Scharfe Löffel
Cucharillas cortantes

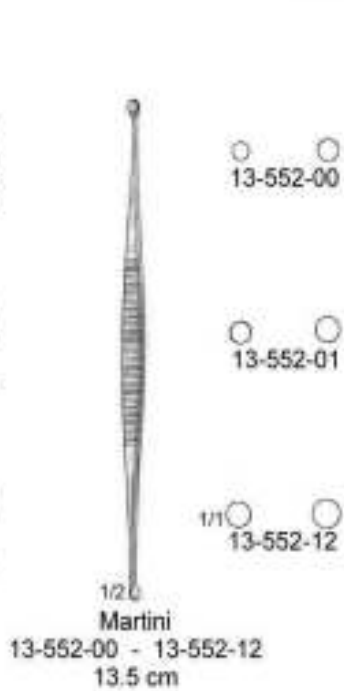
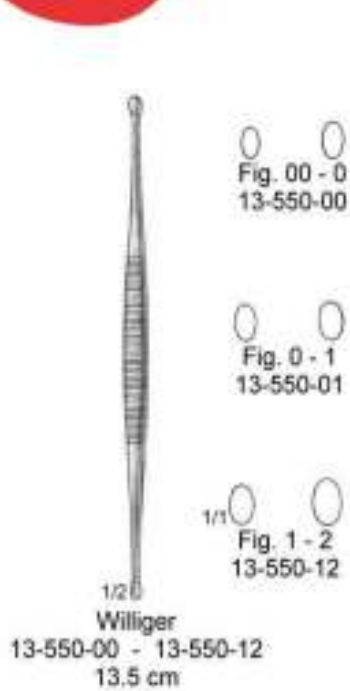

Volkmann
13-564-13 - 13-564-17

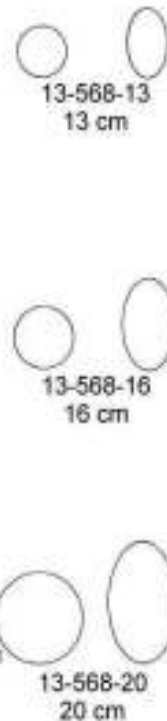

Volkmann
13-568-13 - 13-568-20



Bone Surgery - Knochenchirurgie - Cirugia ósea
Bone Currettes
Scharfe Löffel
Cucharillas cortantes



1/2 1/1
Barth
13-569-18
18 cm



1/2 1/10
House
13-570-15
15.5 cm



1/2 1/10
House
13-571-15
15.5 cm

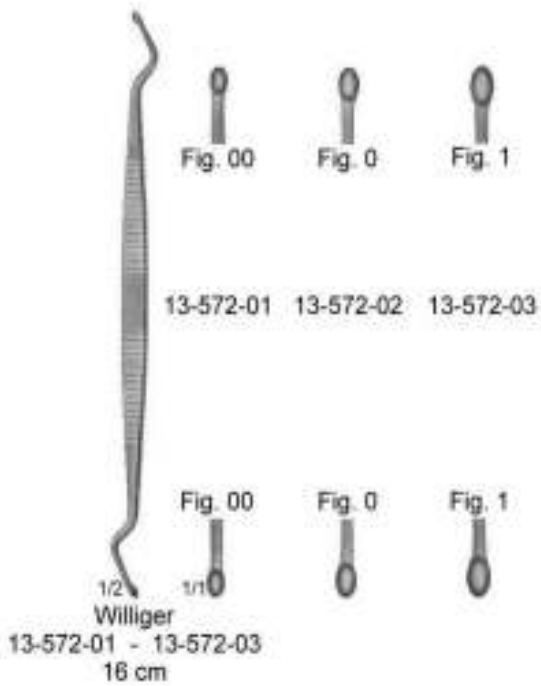

Fig. 00 Fig. 0 Fig. 1
13-572-01 13-572-02 13-572-03
1/2 1/1
Williger
13-572-01 - 13-572-03
16 cm

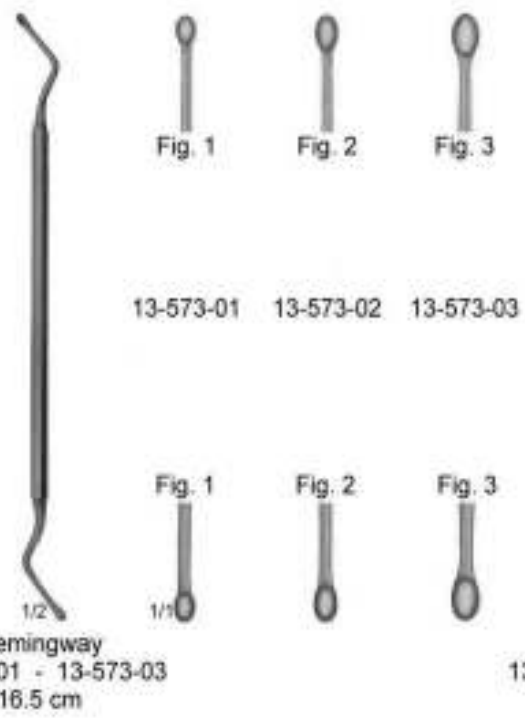

Fig. 1 Fig. 2 Fig. 3
13-573-01 13-573-02 13-573-03
1/2 1/1
Hemingway
13-573-01 - 13-573-03
16.5 cm

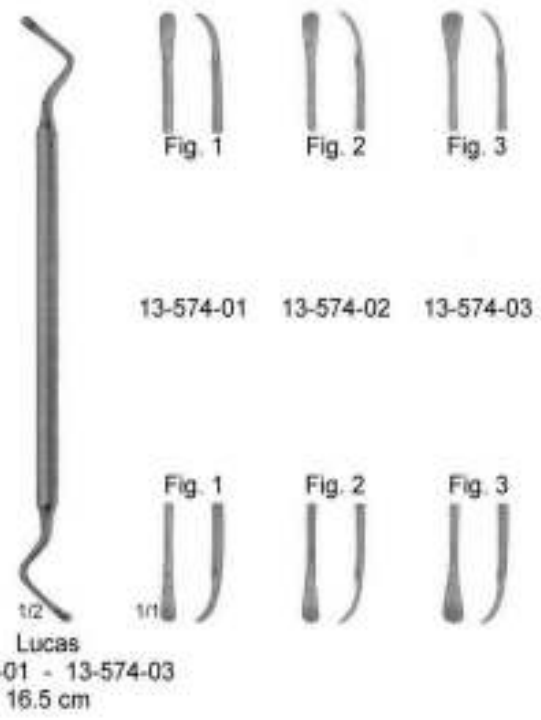
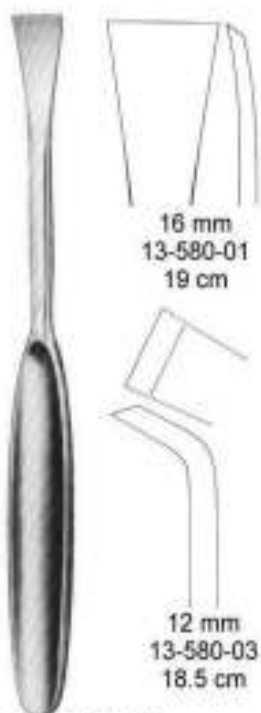

Fig. 1 Fig. 2 Fig. 3
13-574-01 13-574-02 13-574-03
1/2 1/1
Lucas
13-574-01 - 13-574-03
16.5 cm



Bone Surgery - Knochenchirurgie - Cirugía ósea
Periosteal Raspatories
Raspatorien
Legras-Periostótomos



16 mm
13-580-01
19 cm

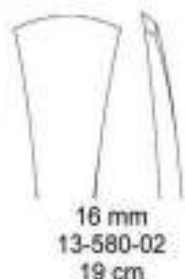

16 mm
13-580-02
19 cm



12 mm
13-580-03
18.5 cm



12 mm
13-580-04
18 cm

Martin - Langenbeck
13-580-01 - 13-580-04



7 mm
13-580-10
16 cm



15 mm
13-580-11
18.5 cm



20 mm
13-580-12
20 cm

Martin - Hoen
13-580-10 - 13-580-12



4 mm
13-580-20
17 cm



5 mm
13-580-21
17 cm

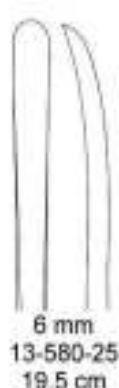

6 mm
13-580-25
19.5 cm



7 mm
13-580-26
19.5 cm

Martin - Cushing
13-580-20 - 13-580-26



8 mm

Martin - Cushing
13-580-30
17 cm



Bone Surgery - Knochenchirurgie - Cirugia ósea
Periosteal Raspatories
Raspatorien
Legras-Periostótomos

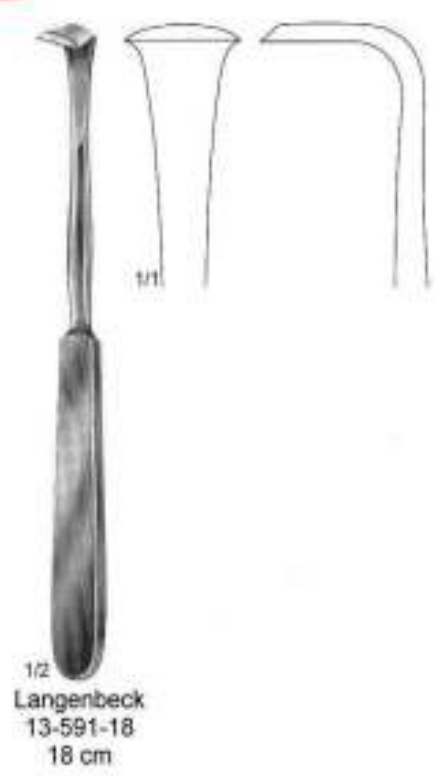

1/2
Langenbeck
13-591-18
18 cm

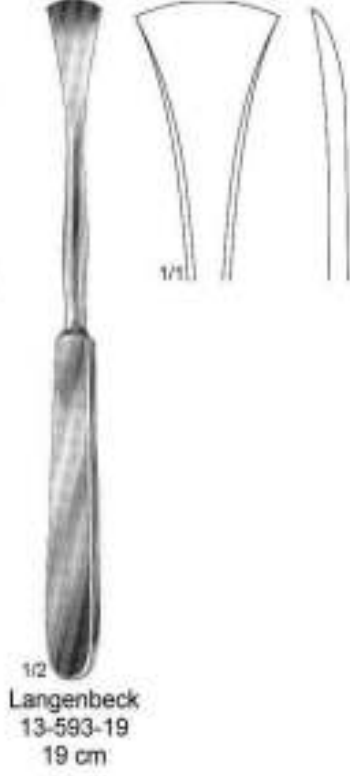

1/2
Langenbeck
13-593-19
19 cm

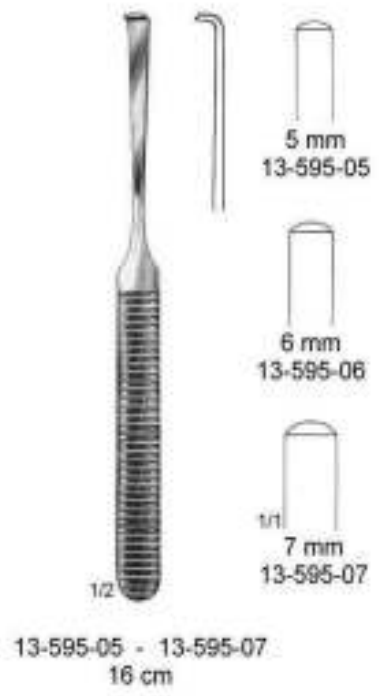

1/2
13-595-05 - 13-595-07
16 cm

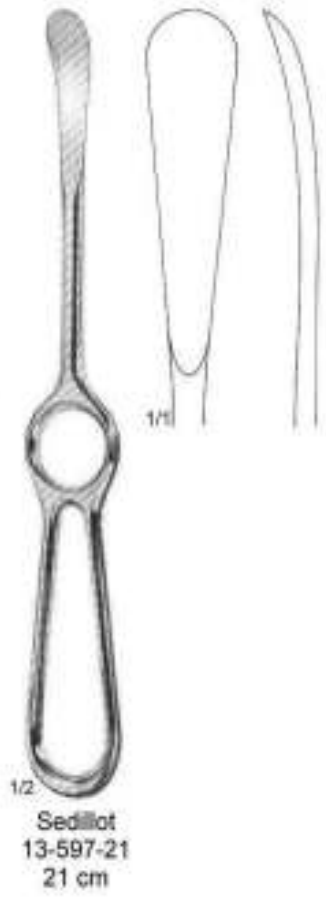

1/2
Sedillot
13-597-21
21 cm

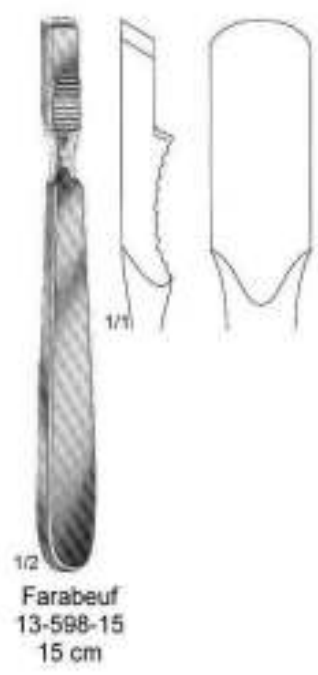

1/2
Farabeuf
13-598-15
15 cm



1/2
Farabeuf
13-599-15
15 cm



Bone Surgery - Knochenchirurgie - Cirugia ósea
Periosteal Raspatories
Raspatorien
Legras-Periostótomos





Bone Surgery - Knochenchirurgie - Cirugia ósea
Periosteal Raspatories
Raspatorien
Legras-Periostótomos



13-585-10
10 mm

Handle from artificial wood



13-585-13
13 mm



13-585-19
19 mm



13-585-25
25 mm



21 mm

1/1

1/2

13-587-27
27.5 cm



13-589-08
8 mm



13-589-17
17 mm



1/1

1/2

Cobb
13-585-10 - 13-585-25
25 cm



1/2

Wagner
13-589-06 - 13-589-17
33 cm



Bone Surgery - Knochenchirurgie - Cirugia ósea
Periosteal Raspatories
Raspatorien
Legras-Periostótomos

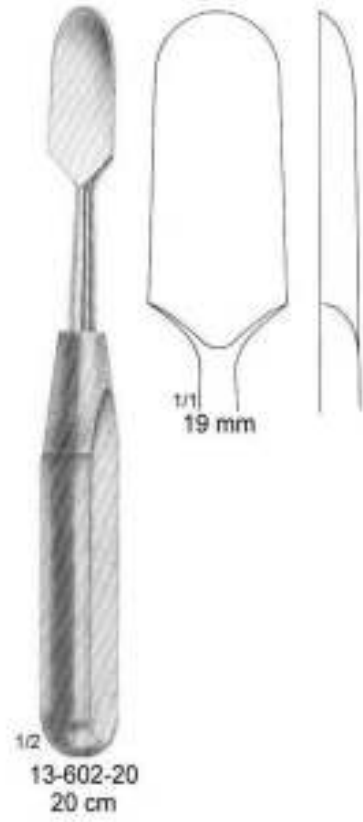

Handle from artificial wood





Bone Surgery - Knochenchirurgie - Cirurgia ósea
Periosteal Raspatories
Raspatorien
Legras-Periostótomos

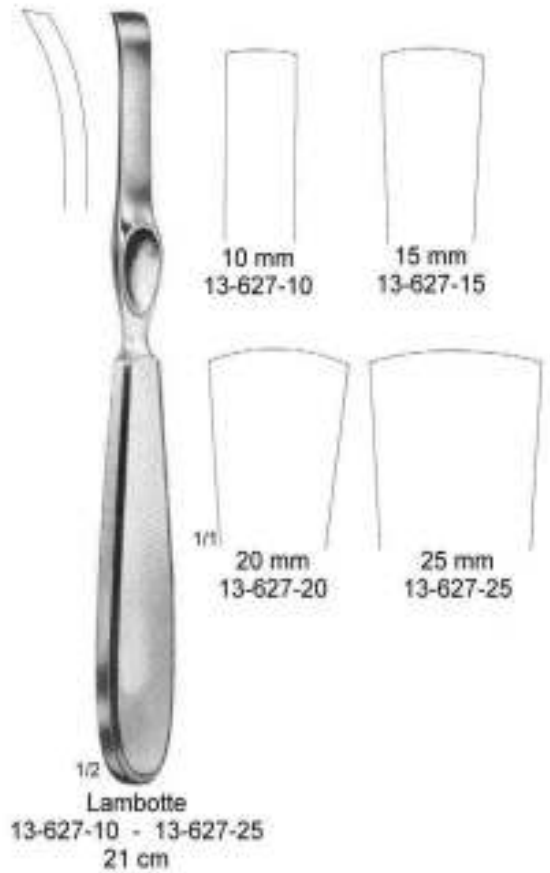
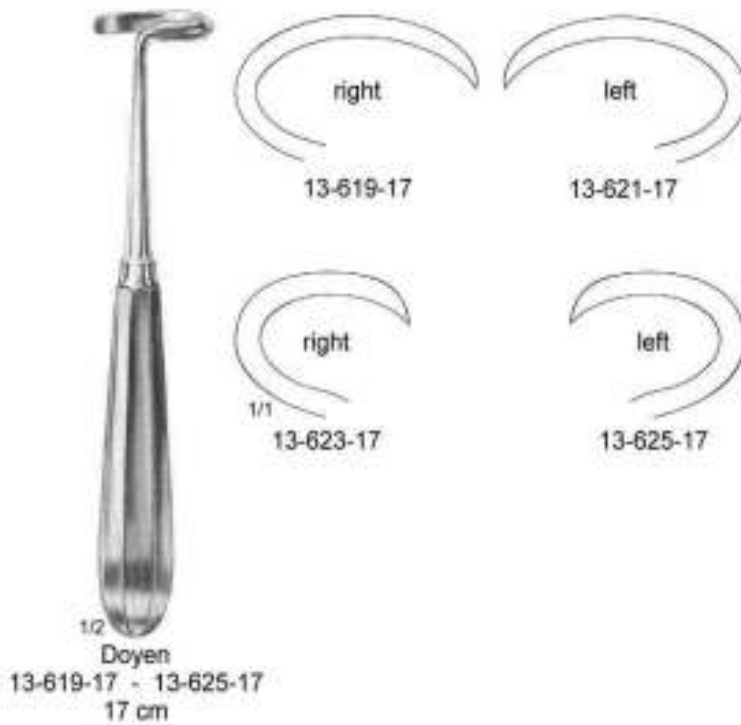
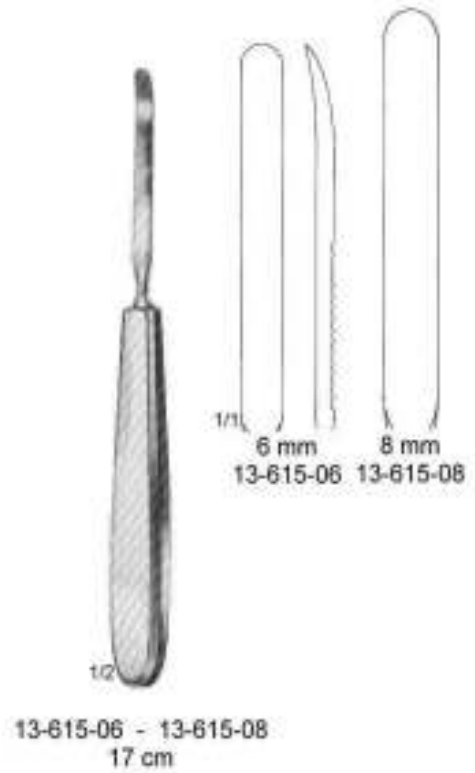
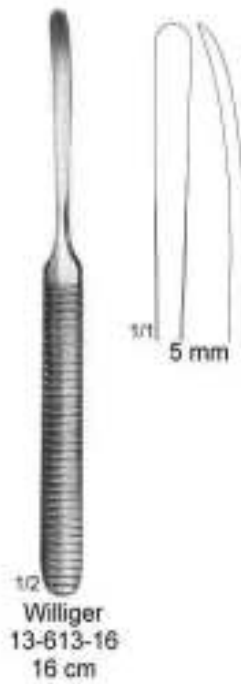
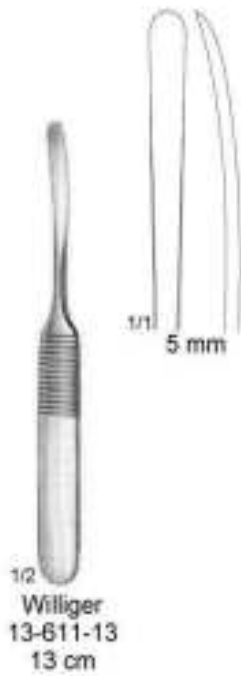



Bone Surgery - Knochenchirurgie - Cirugía ósea
Periosteal Raspatories
Raspatorien
Legras-Periostótomos

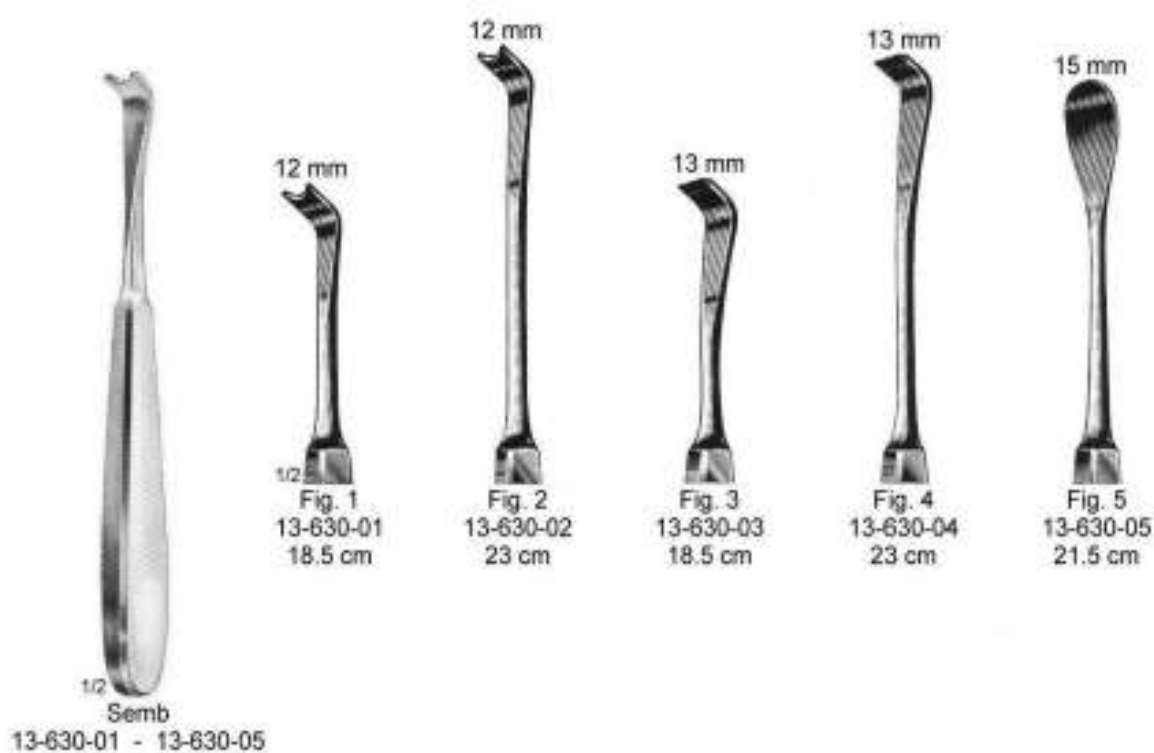



Bone Surgery - Knochenchirurgie - Cirugía ósea
Periosteal Raspatories
Raspatorien
Legras-Periostótomos



Semb
13-632-01 - 13-632-05



Fig. 1
13-632-01
17.5 cm



Fig. 2
13-632-02
21 cm



Fig. 3
13-632-03
17.5 cm



Fig. 4
13-632-04
21 cm



Fig. 5
13-632-05
20.5 cm



Alexander
13-634-20
20 cm



Matson
13-636-22
22 cm



Bone Surgery - Knochenchirurgie - Cirugia ósea
Bone Files
Knochenfeile
Lima para huesos

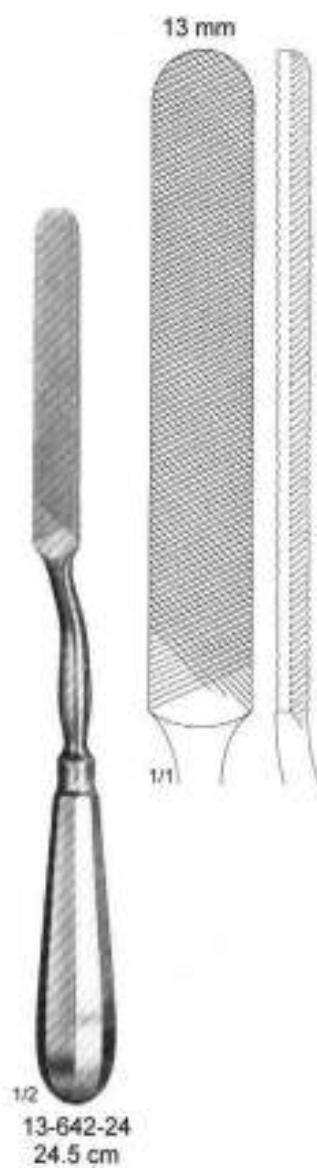



Bone Surgery - Knochenchirurgie - Cirurgia ósea
Rasps, Tampers
Raspeln, Stößel
Escofinas, Punzón

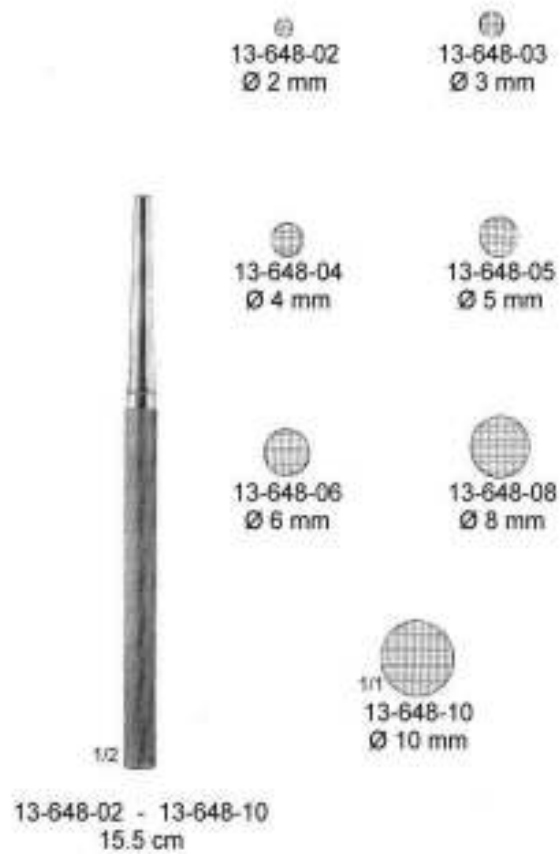



Bone Surgery - Knochenchirurgie - Cirugia ósea
Elevators
Elevatorii
Elevadores

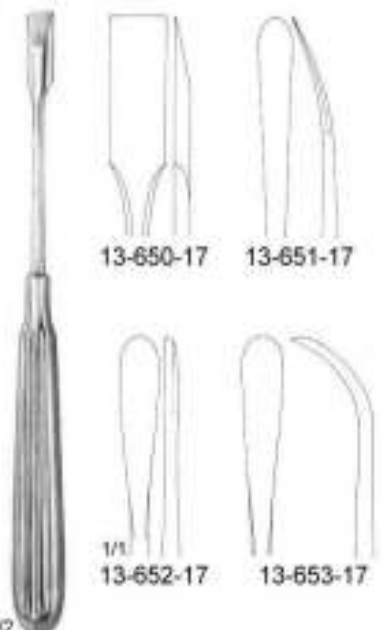

1/2 Adson
13-650-17 - 13-653-17
17 cm

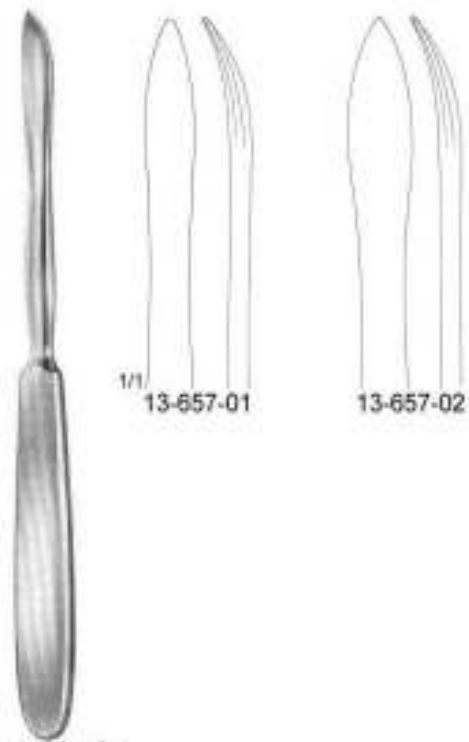

Langenbeck
13-657-01 - 13-657-02
19 cm

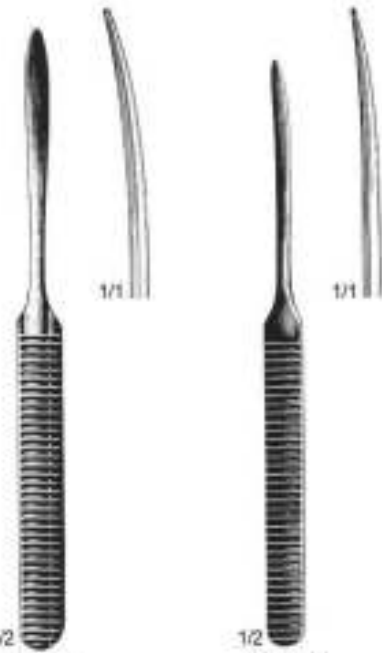

1/2 Williger
13-661-17
17 cm

1/2 Williger
13-663-16
16 cm

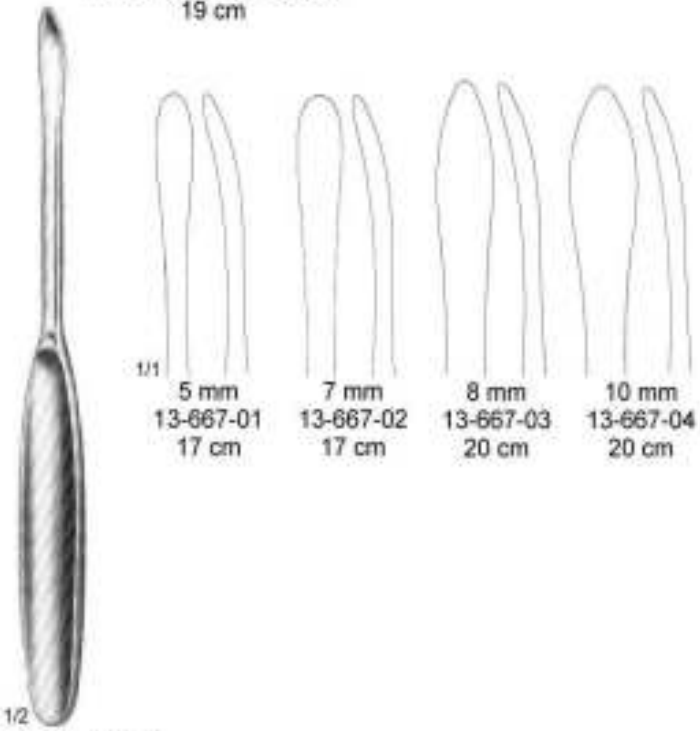

1/2 Martin-Langenbeck
13-667-01 - 13-667-04



Bone Surgery - Knochenchirurgie - Cirugía ósea
Elevators
Elevatorien
Elevadores



9.5 mm
13-670-01



13 mm
13-670-02



1/1
19 mm
13-670-03



1/2
Cobb
13-670-01 - 13-670-03
28 cm

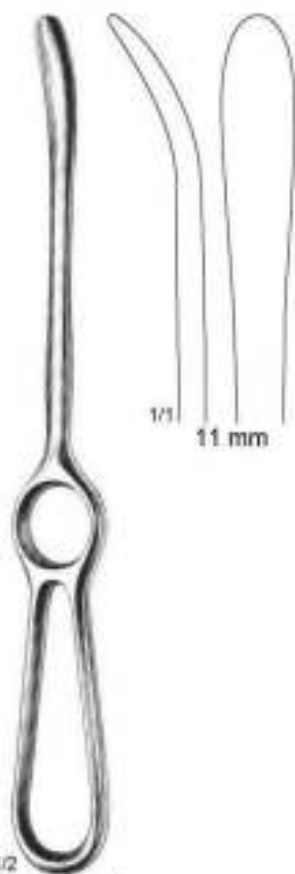

1/2
Langenbeck
13-673-23
23 cm



1/1
11 mm

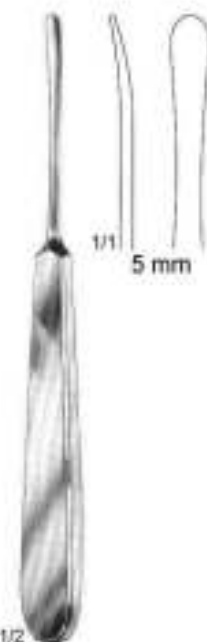

1/2
Sebilleau
13-675-17
17.5 cm



1/1
5 mm



Bone Surgery - Knochenchirurgie - Cirugia ósea
Elevators
Elevatoriën
Elevadores

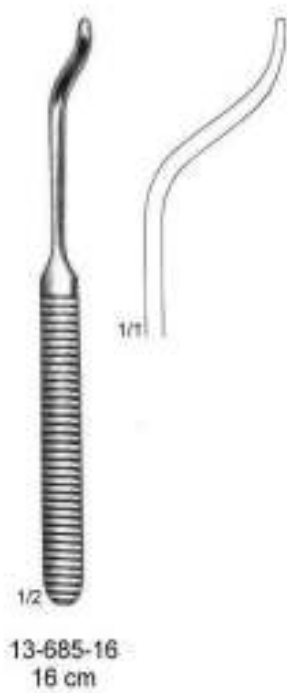



Bone Surgery - Knochenchirurgie - Cirugia ósea
Bone Levers
Knochenhebel
Elevadores para huesos

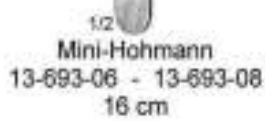
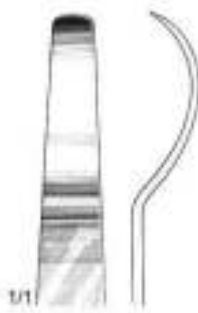
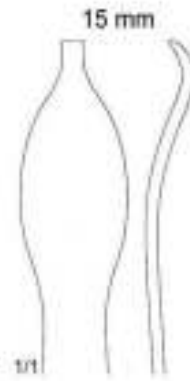
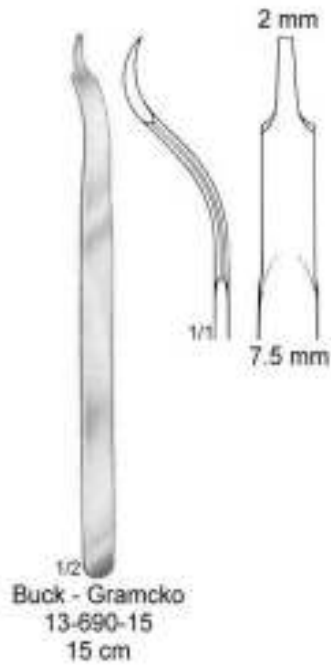



Bone Surgery - Knochenchirurgie - Cirugía ósea
Bone Levers
Knochenhebel
Elevadores para huesos

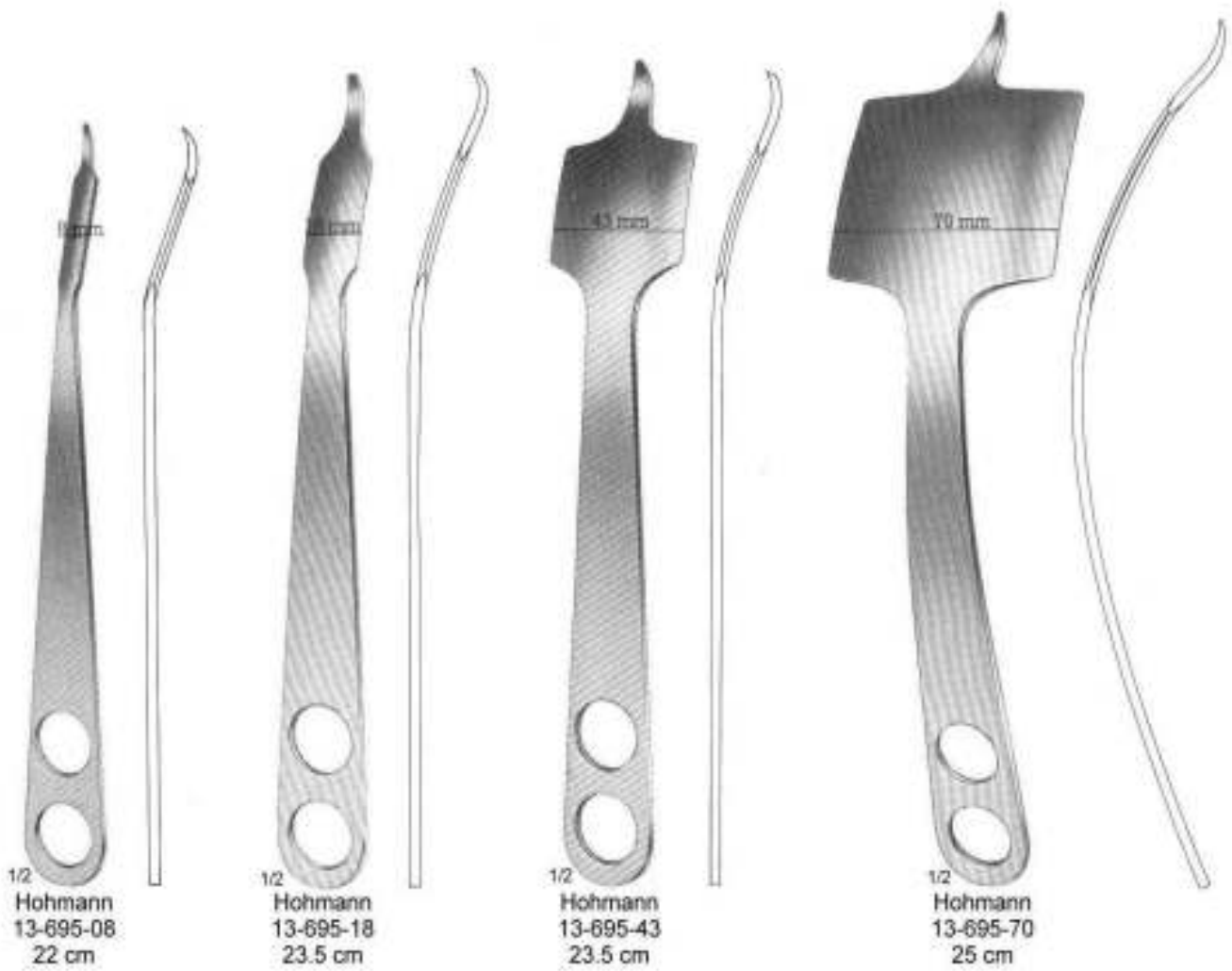



Bone Surgery - Knochenchirurgie - Cirugía ósea
Bone Levers
Knochenhebel
Elevadores para huesos

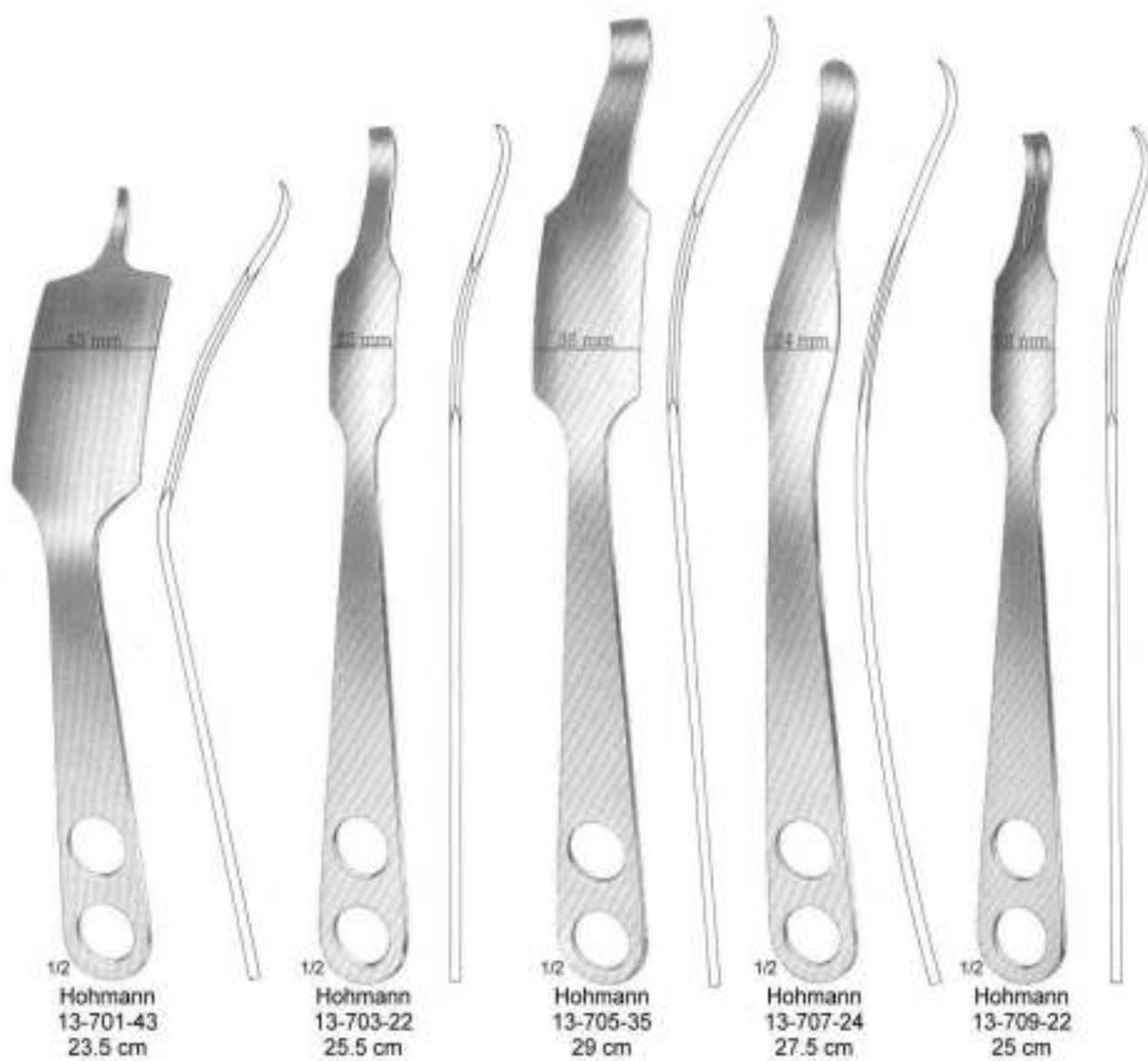



Bone Surgery - Knochenchirurgie - Cirugía ósea
Bone Levers
Knochenhebel
Elevadores para huesos



Bennett
13-711-43 - 13-711-60
24 cm





Bone Surgery - Knochenchirurgie - Cirugía ósea
 Bone Levers
 Knochenheber
 Elevadores para huesos

13-712-01 13-712-02
 26.5 cm 29 cm
 30 mm 33 mm



Lange - Hohmann Modif
 13-712-01 - 13-712-02



Hohmann - Aldinger
 13-712-03
 27 cm



Schumacher
 13-712-04
 34.5 cm
 (Wagner)



Schumacher
 13-712-05
 29 cm



Bone Surgery - Knochenchirurgie - Cirugia ósea
 Bone Levers
 Knochenheber
 Elevadores para huesos

13-713-01
 32 x 19 mm

13-713-02
 48 x 19 mm

13-713-03
 57 x 19 mm



Smillie

13-713-01 - 13-713-05
 14 cm



13-713-04
 52 x 13 mm



13-713-05
 12 x 13 mm



Wagner
 13-713-06
 22 cm



Murphy - Lane
 13-713-07
 32 cm

13-713-08
 18 cm 13 mm

13-713-09
 20 cm 19 mm

13-713-10
 23 cm 25 mm

13-713-11
 25 cm 30 mm



Chandler
 13-713-08 - 13-713-11



Bone Surgery - Knochenchirurgie - Cirugía ósea
Bone Levers
Knochenheber
Elevadores para huesos

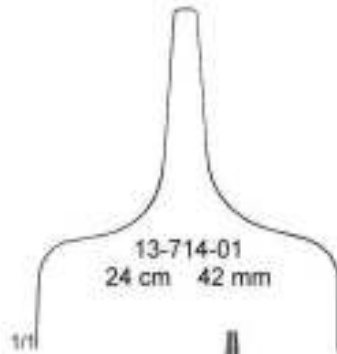
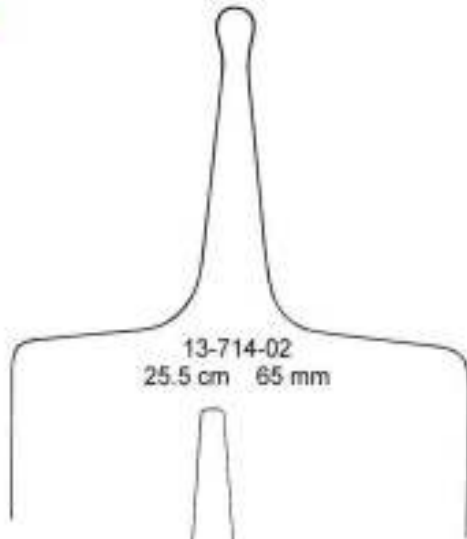

Verbrugge - Müller
13-714-01 - 13-714-02



Lane Trethowan
13-714-03
21.5 cm



Lane
13-714-04
25.5 cm



Bone Surgery - Knochenchirurgie - Cirugia ósea
Bone Levers
Knochenhebel
Elevadores para huesos



1/3
Blount
13-715-26
26 cm



1/3
Blount
13-717-26
26 cm

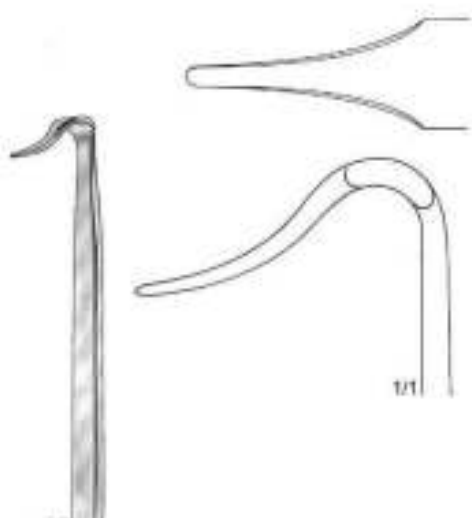

1/3
Blount
13-719-27
17 cm



1/3
Taylor
13-721-16 - 13-723-16
16.5 cm



13-723-16
100 x 30 mm

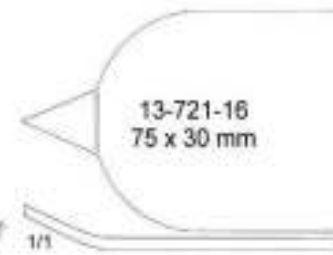

13-721-16
75 x 30 mm



Bone Surgery - Knochenchirurgie - Cirugia ósea
 Meniscotomy Knives
 Meniskotome
 Bisturies para meniscos

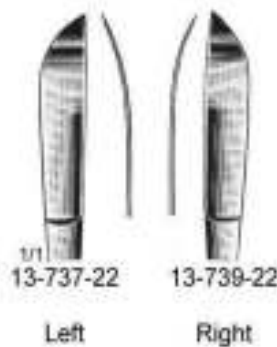
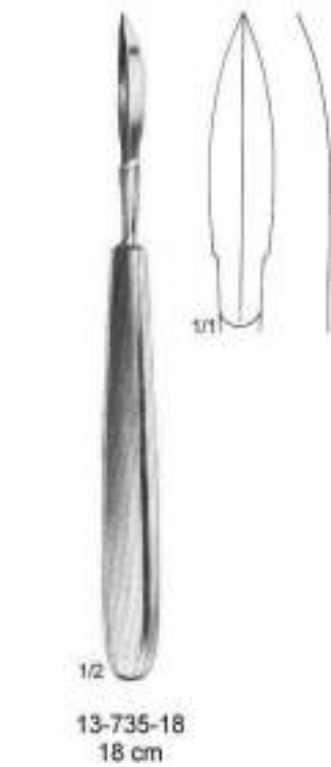
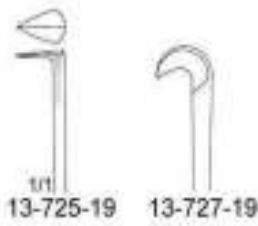



Bone Surgery - Knochenchirurgie - Cirugía ósea
 Tendon Stripper, Tendon Tunnel Instruments
 Sehnenstripper, Durchzuginstrumente
 Separafiores para tendones

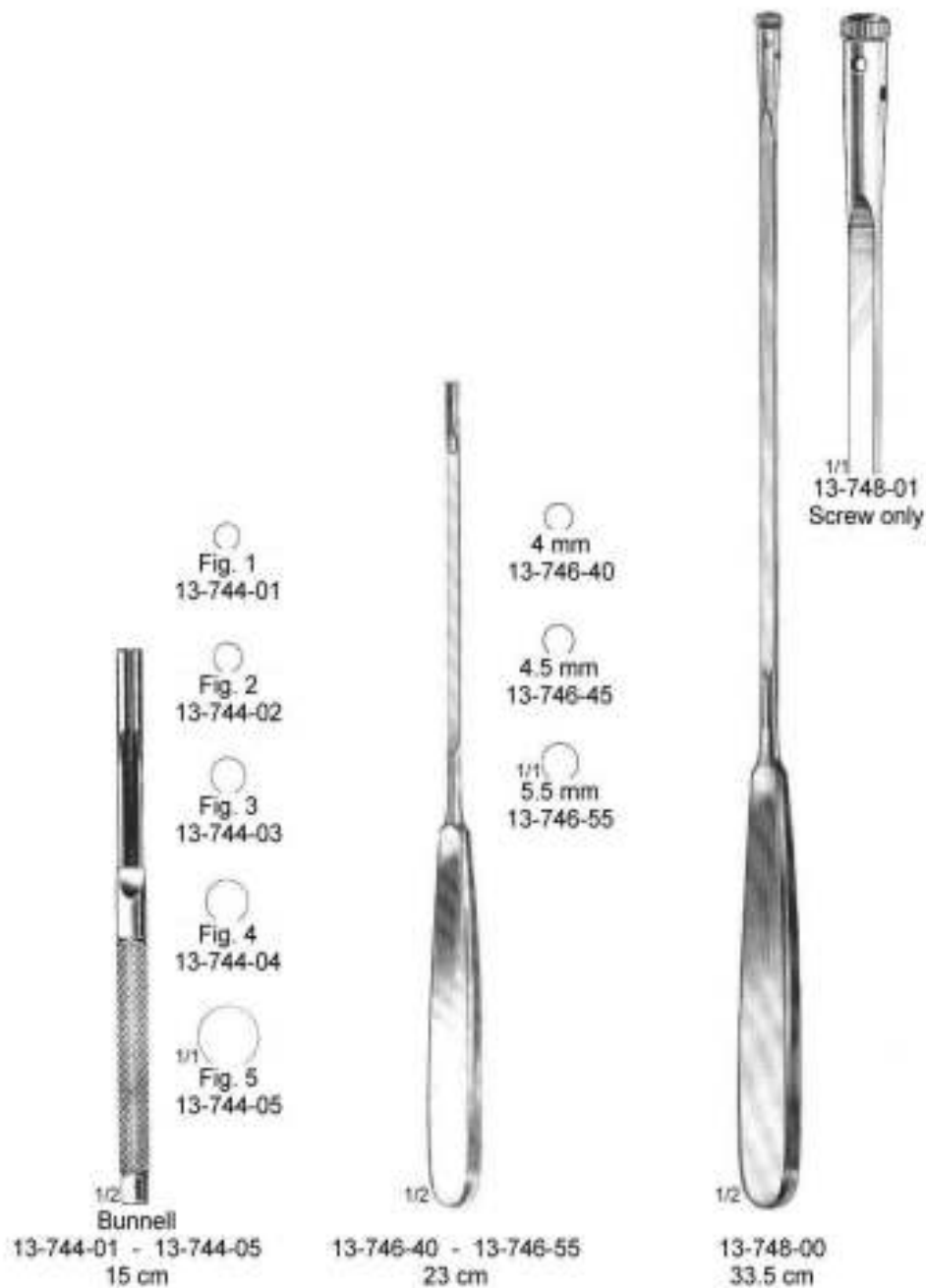



Bone Surgery - Knochenchirurgie - Cirugía ósea
Tendon Stripper, Tendon Tunnel Instruments
Sehnenstripper, Durchzuginstrumente
Instrumentos para el túnel del tendón



Bone Surgery - Knochenchirurgie - Cirugía ósea
 Tendon Seizing Instruments
 Schenfaßinstrumente
 Instrumentos para coger tendones



1/2
 Steinmann
 13-758-16
 16 cm

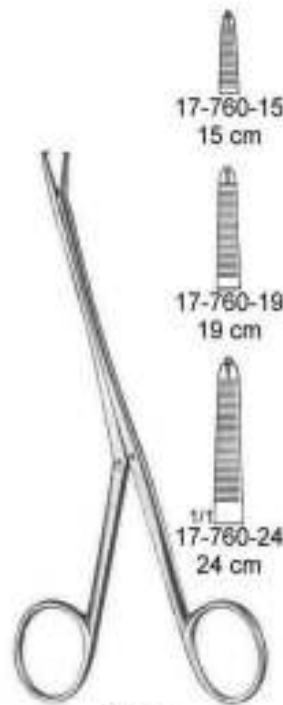

Brand
 13-760-15 - 13-760-24

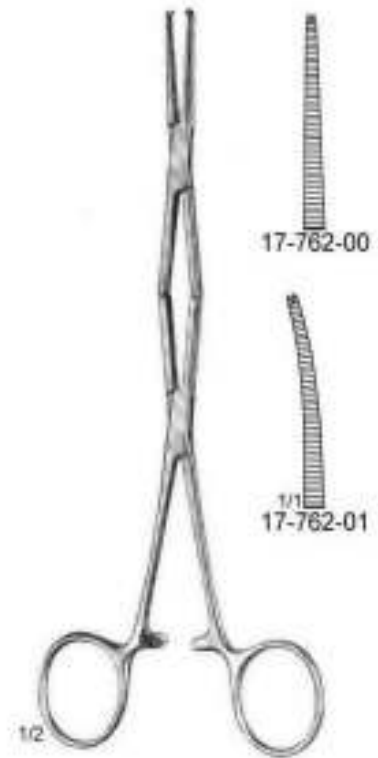

13-762-00 - 13-762-01
 20.5 cm

Fine Serrations

Coarse Serrations



Herz
 13-764-01 - 13-764-02
 15.5 cm



13-764-02



Carol
 13-765-11
 11 cm



Bone Surgery - Knochenchirurgie - Cirugia ósea
Tendon Seizing Instruments
Schnenfaßinstrumente
Instrumentos para coger tendones



13-766-13
13 cm

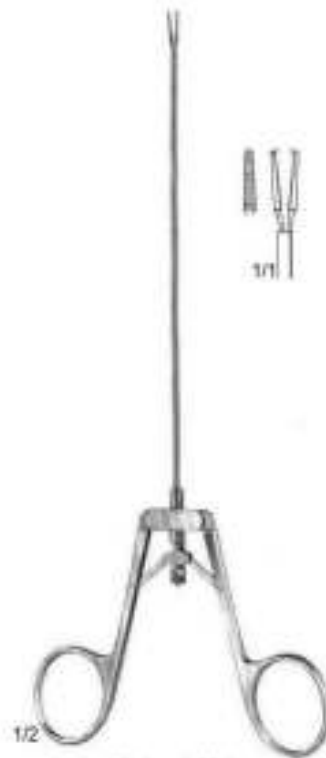

Kleinert-Kutz
13-767-20
20 cm

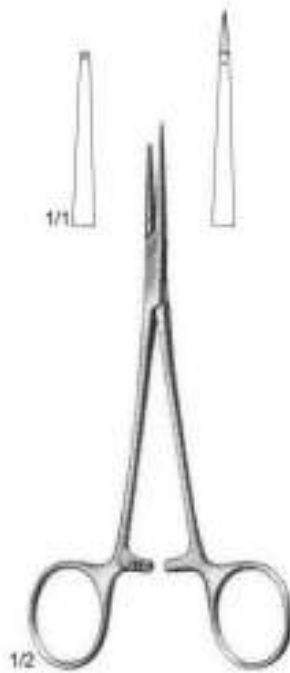

13-768-15
15 cm

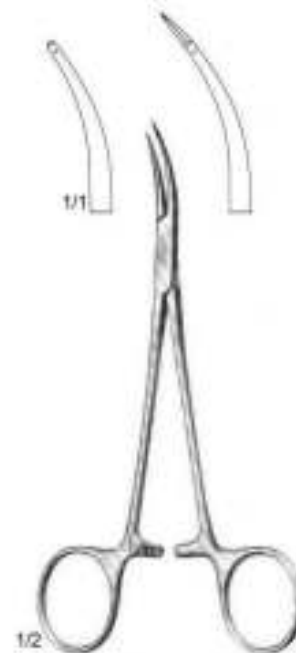

13-769-15
15 cm

Bone Surgery - Knochenchirurgie - Cirugia ósea
 Reposition Forceps, Sequestrum Forceps
 Repositionszangen, Sequesterzangen
 Pinzas para huesos y para secuestros



Reill
 13-770-20
 20 cm

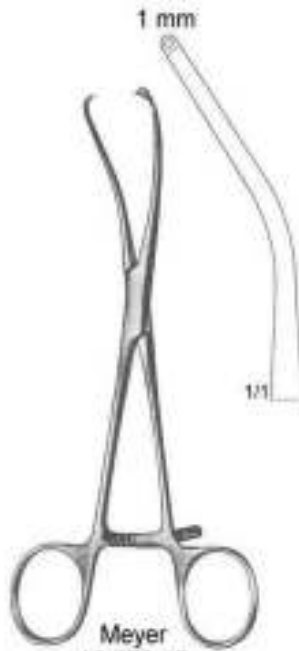

Meyer
 13-772-17
 17 cm



Meyer
 13-772-20
 20.5 cm



Patella
 13-774-18
 18 cm



13-776-20 - 13-777-20
 20 cm

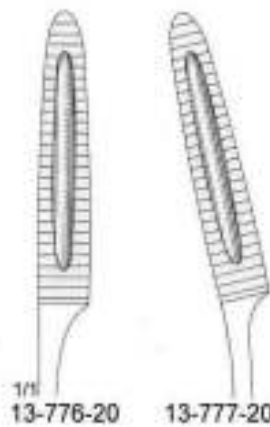

13-776-20 13-777-20



Van Buren
 13-778-23
 23cm

Bone Surgery - Knochenchirurgie - Cirugia ósea
 Meniscus and cartilage forceps
 Meniskus- und Knorpelfaßzangen
 Pinzas para menisco y cartilago

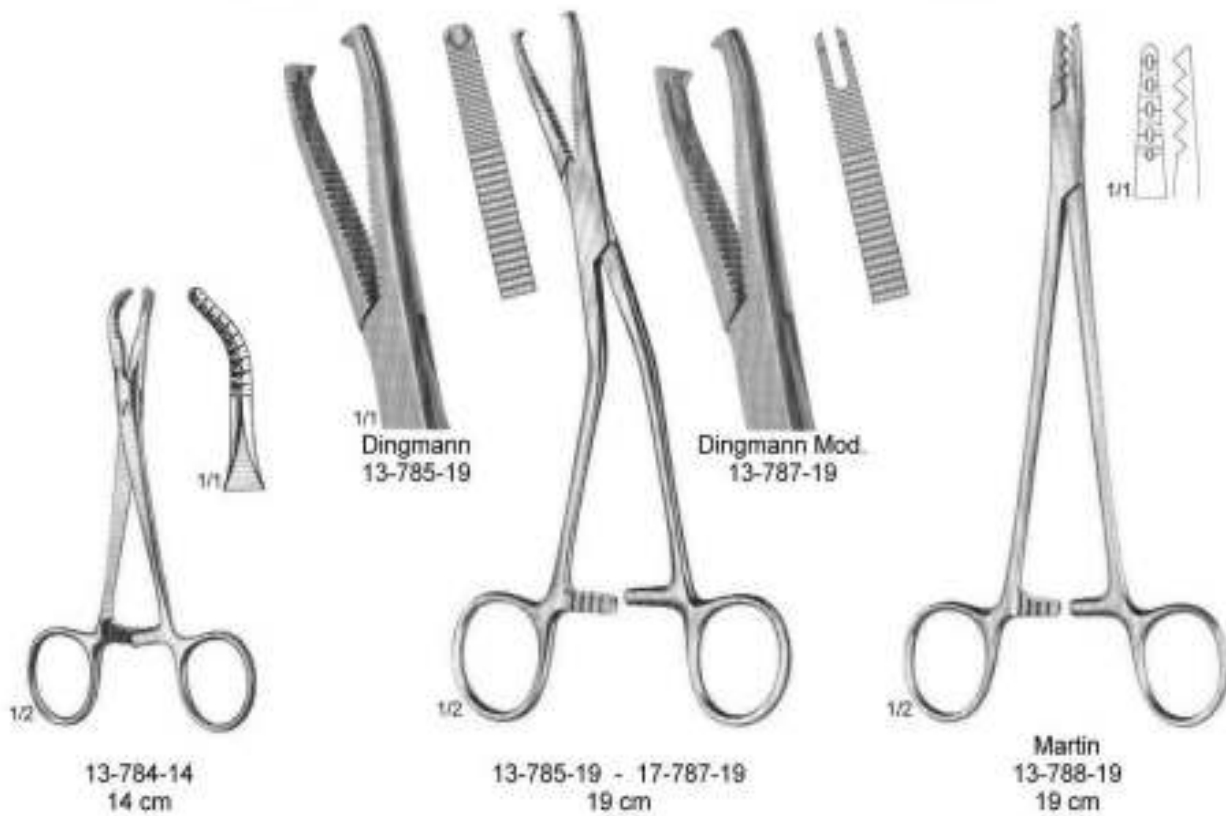
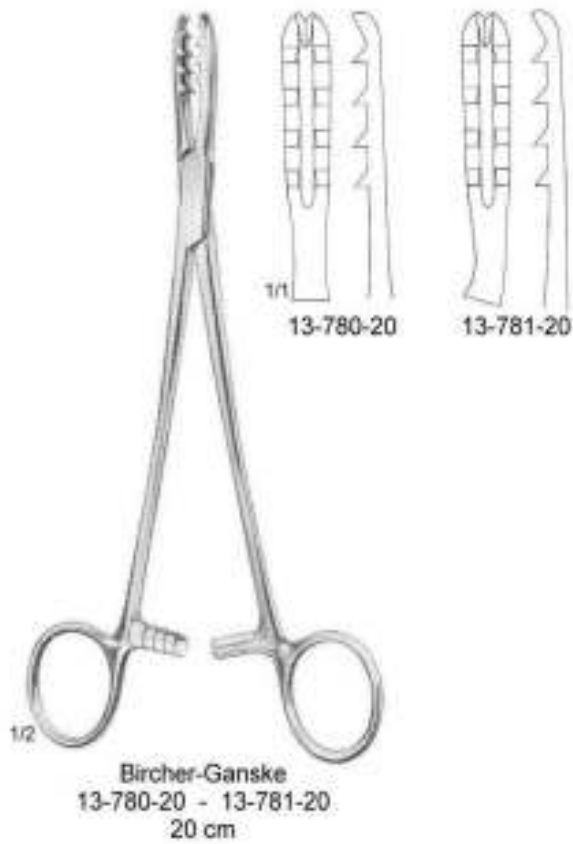

Bone Surgery - Knochenchirurgie - Cirugia ósea
 Bone Holding Forceps
 Knochenhaltezaugen
 Pinzas para huesos



13-791-12
12 cm



Lewin
13-792-17
17.5 cm



13-795-16 - 13-795-24



13-795-16
16 cm

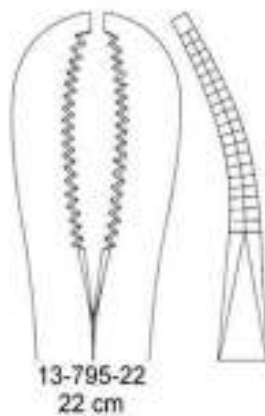

13-795-22
22 cm

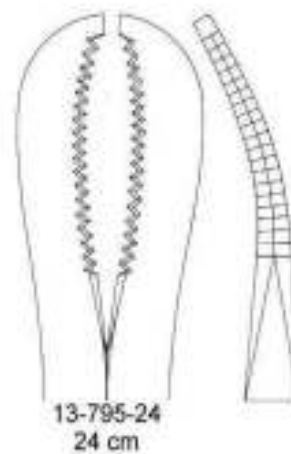

13-795-24
24 cm

Reposition forceps with thread fixation



Bone Surgery - Knochenchirurgie - Cirugia ósea
Bone Holding Forceps
Knochenhaltezaugen
Pinzas para huesos



13-800-14
14 cm



13-801-13
13.5 cm

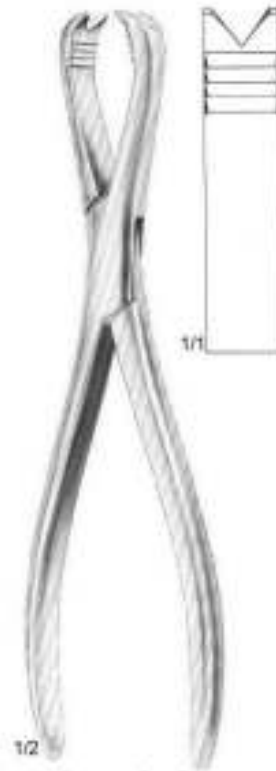

Langenbeck
13-802-21
21 cm

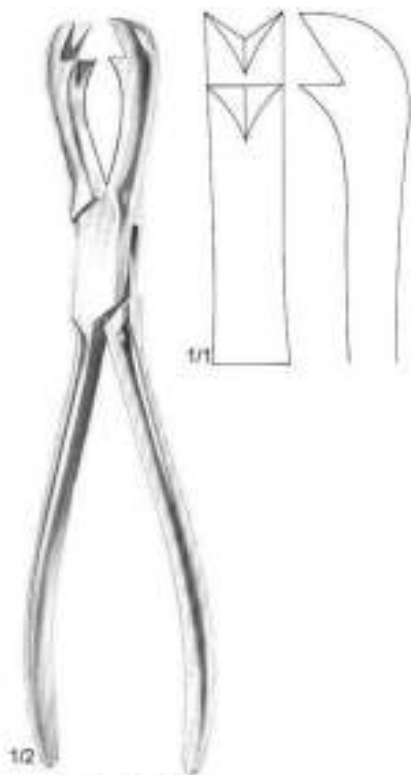

Fergusson
13-804-21
21 cm

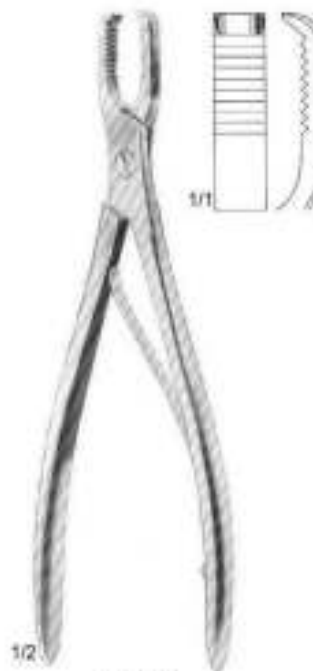

Frosch
13-806-18
18 cm



13-808-20
20 cm

Bone Surgery - Knochenchirurgie - Cirugia ósea
 Bone Holding Forceps
 Knochenhaltezaugen
 Pinzas para huesos



13-817-21
21 cm



13-817-26
26 cm



1/2
13-817-33
33 cm



1/2
Lambotte
13-817-21 - 13-817-33



1/2
Lambotte
13-819-19 19 cm
13-819-23 23 cm
13-819-26 26 cm

Bone Surgery - Knochenchirurgie - Cirugía ósea
 Bone Holding Forceps
 Knochenhaltezaugen
 Pinzas para huesos

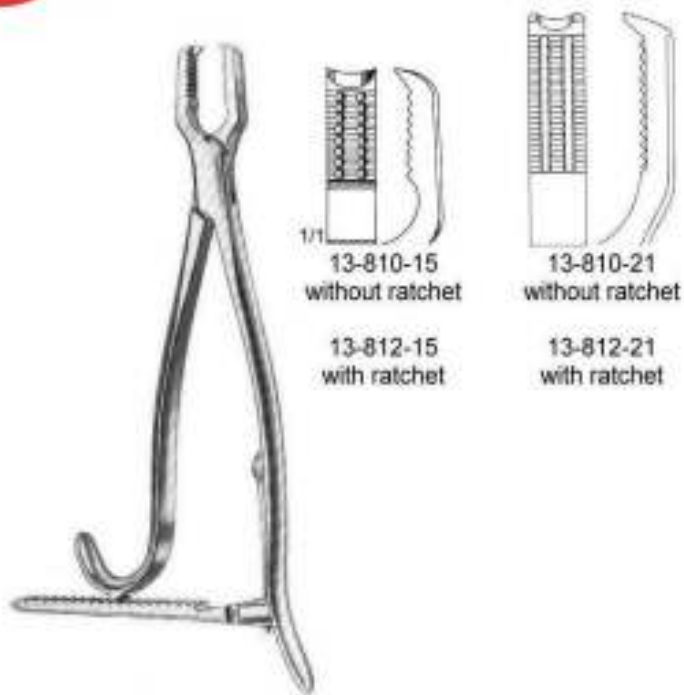

| | Kern | |
|-----------|-------|-----------|
| 13-810-15 | 15 cm | 13-812-15 |
| 13-810-17 | 17 cm | 13-812-17 |
| 13-810-21 | 21 cm | 13-812-21 |



Bone Surgery - Knochenchirurgie - Cirugía ósea
 Bone Holding Forceps
 Knochenhaltezaugen
 Pinzas para huesos

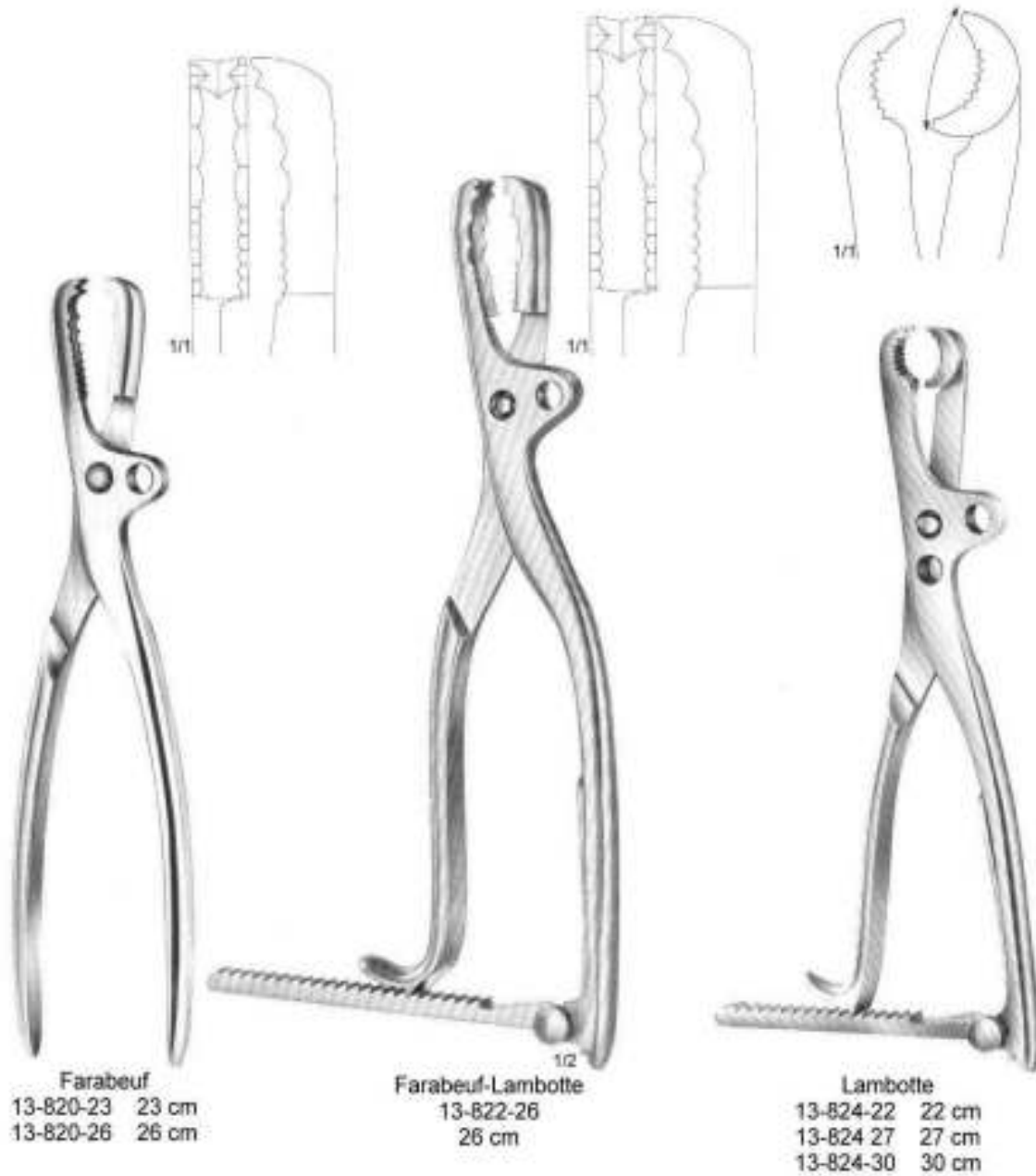

Bone Surgery - Knochenchirurgie - Cirugía ósea
 Bone Holding Forceps
 Knochenhaltezaugen
 Pinzas para huesos



1/1



13-826-23
 13-827-23
 23 cm

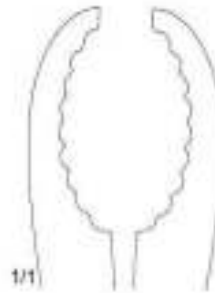

1/1

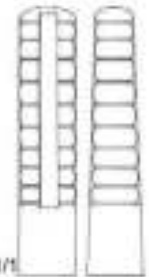

1/1



Ulrich
 13-826-23 - 13-826-28



13-826-25
 13-827-25
 25 cm



1/1

13-826-28
 13-827-28
 28 cm



Ulrich
 13-827-23 - 13-827-28



Bone Surgery - Knochenchirurgie - Cirugía ósea
Bone Holding Forceps
Knochenhaltezaugen
Pinzas para huesos

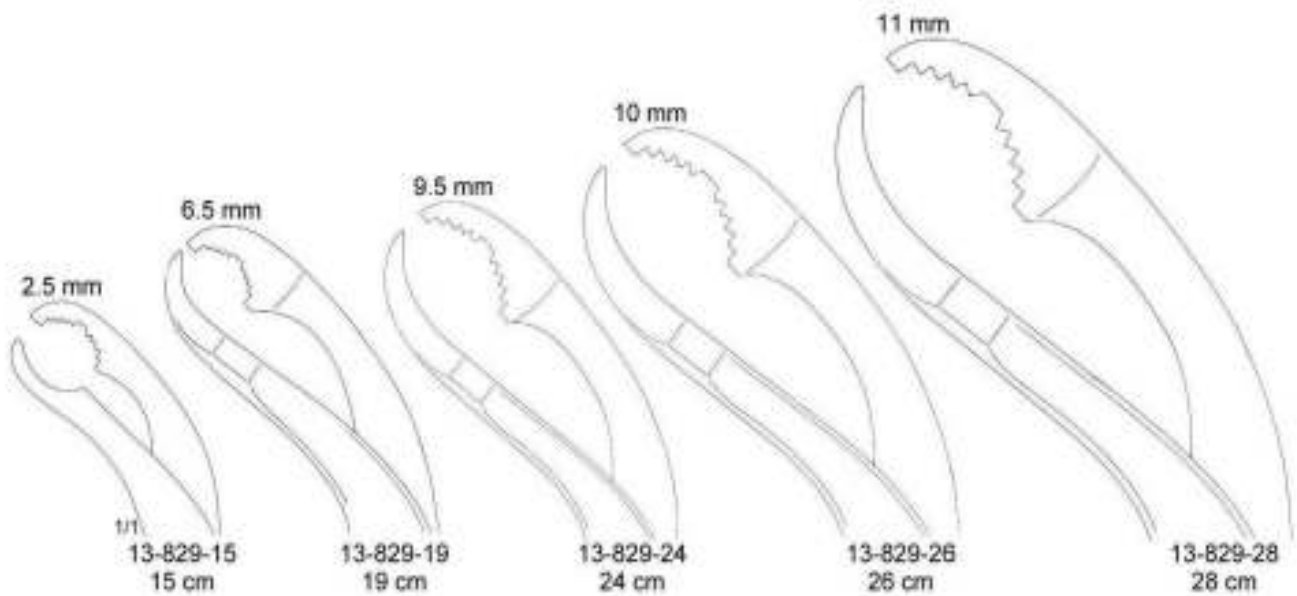

13-829-15 - 13-829-28
Self-centering forceps with thread fixation



Bone Surgery - Knochenchirurgie - Cirugía ósea
Bone Holding Forceps
Knochenhaltezaugen
Pinzas para huesos

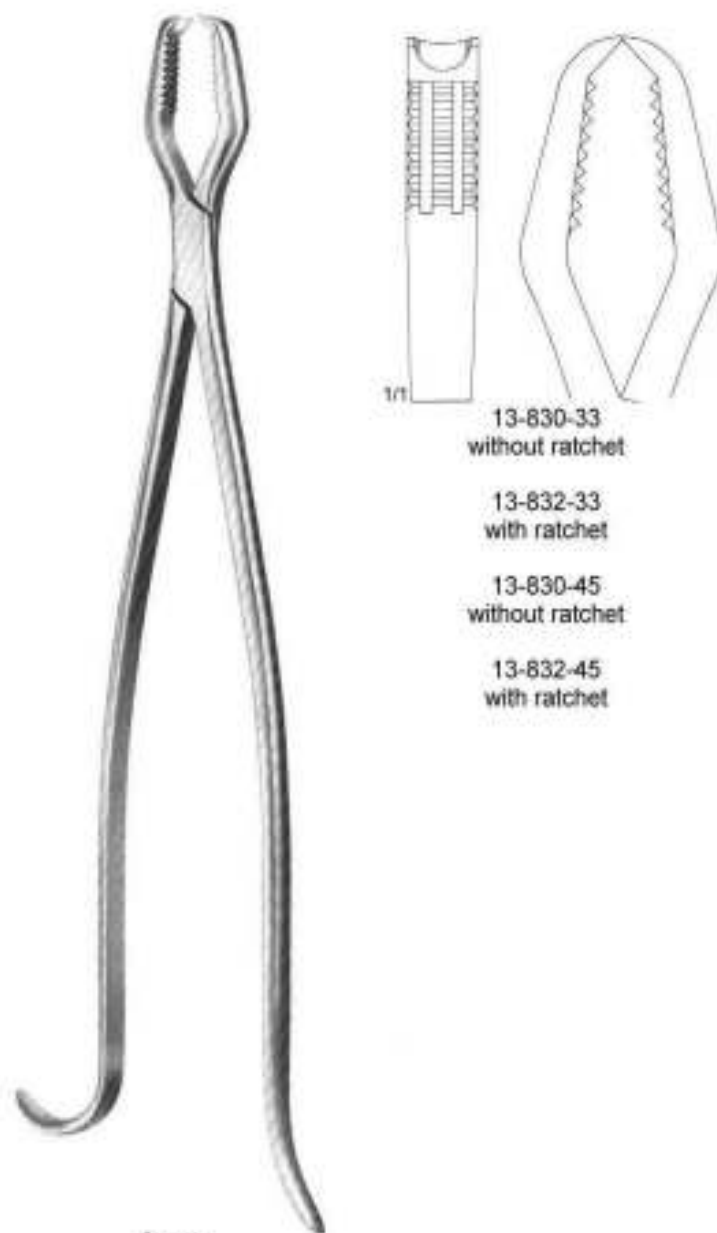

13-830-33
without ratchet

13-832-33
with ratchet

13-830-45
without ratchet

13-832-45
with ratchet

| | Lane | |
|-----------|-------|-----------|
| 13-830-33 | 33 cm | 13-832-33 |
| 13-830-45 | 45 cm | 13-832-45 |



Bone Surgery - Knochenchirurgie - Cirugía ósea
Bone Holding Forceps
Knochenhaltezaugen
Pinzas para huesos



1/2
Hey Groves
13-834-21
21 cm

1/2
Hey Groves
13-834-27
27 cm

1/2
Hey Groves
13-834-30
30.5 cm



Bone Surgery - Knochenchirurgie - Cirugía ósea
Bone Holding Forceps, Retractors
Knochenhaltezaugen, Retraktoren
Pinzas para huesos, Retractores

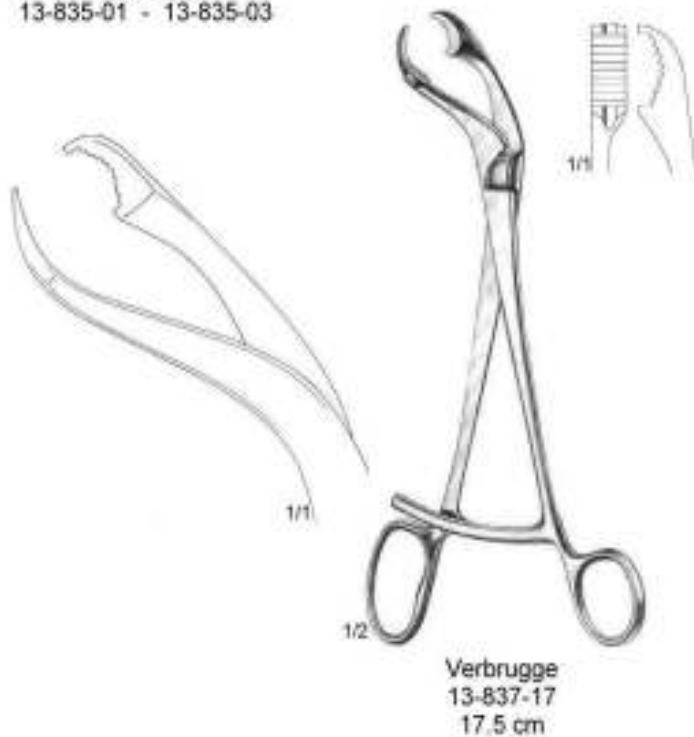
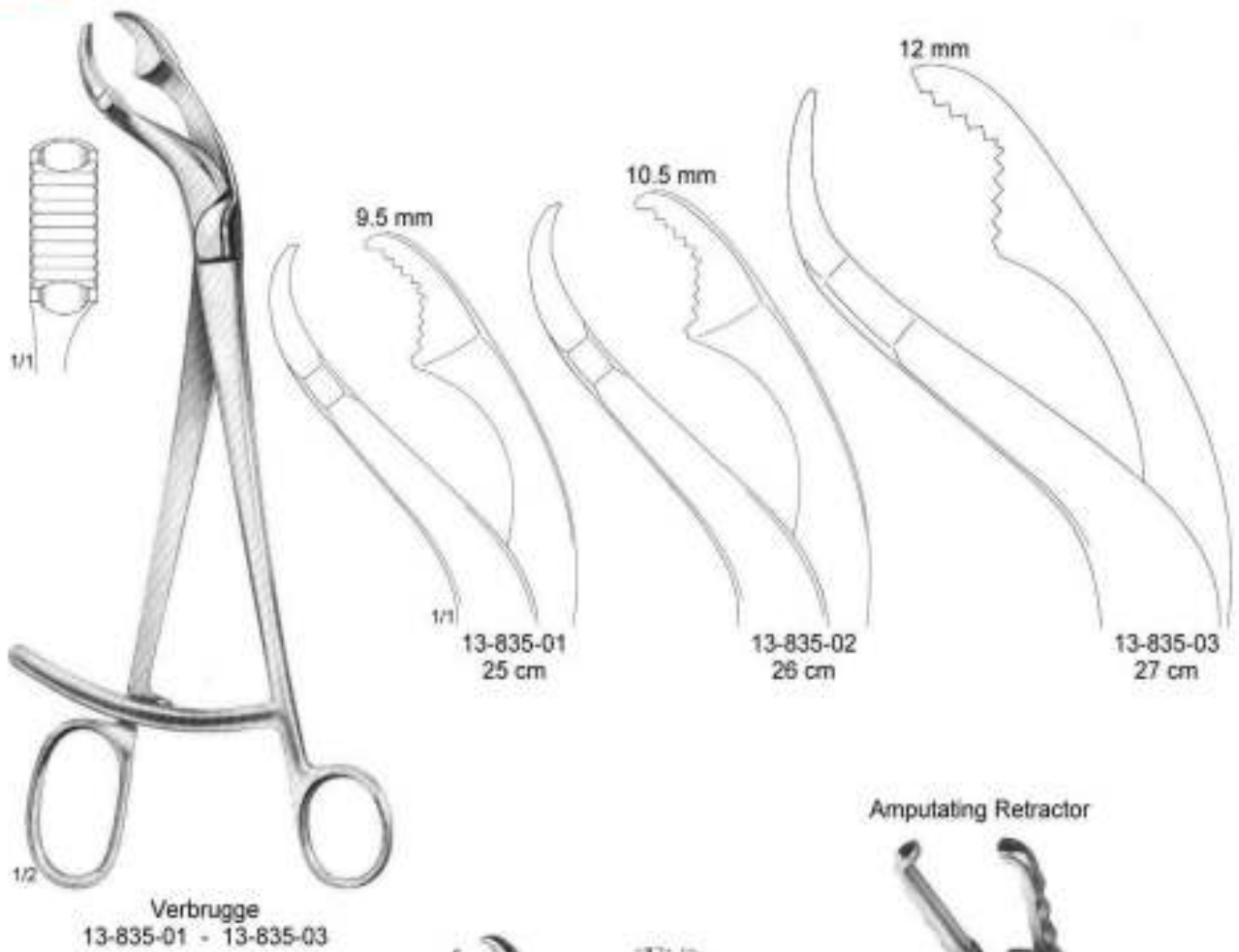

Amputating Retractor



Bone Surgery - Knochenchirurgie - Cirugia ósea
 Bone Rongeur Forceps
 Hohlmeißelzangen
 Pinzas-gubias

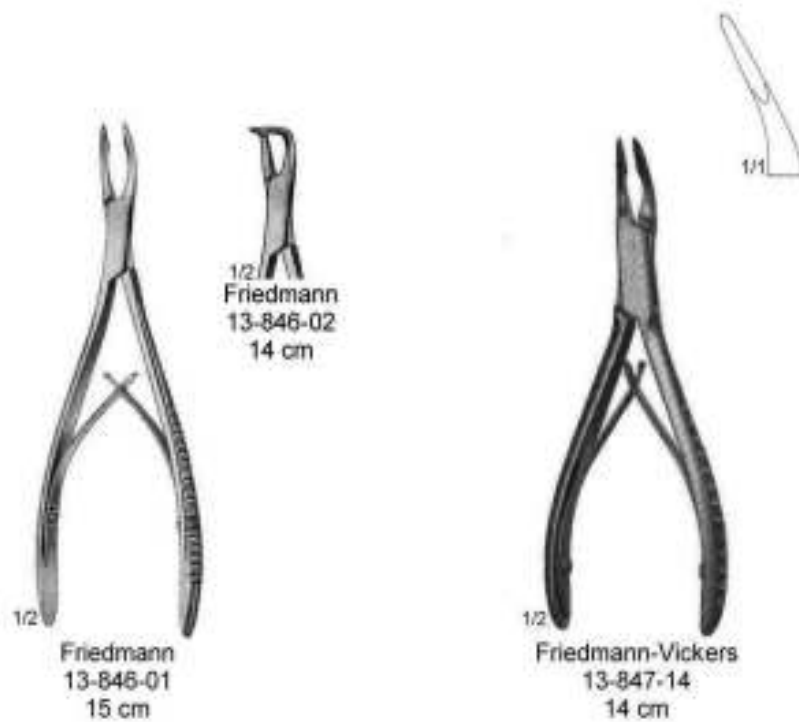
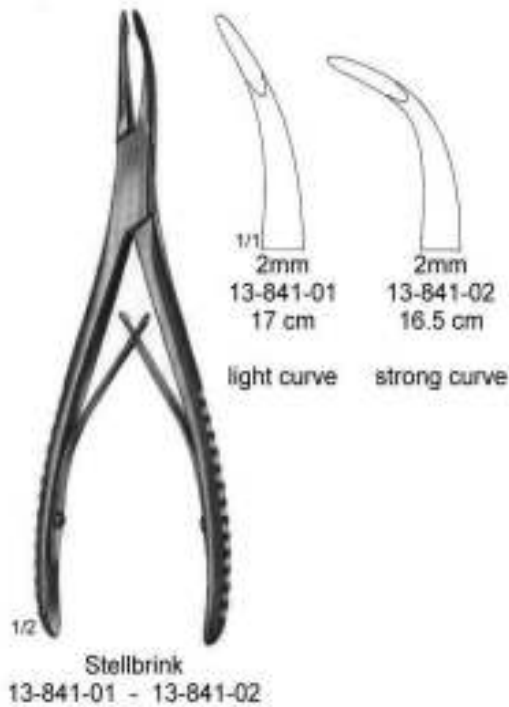

Bone Surgery - Knochenchirurgie - Cirugia ósea
 Bone Rongeur Forceps
 Hohlmeißelzangen
 Pinzas-gubias



1/2
Cohen
13-849-14
14 cm



1/2
Hakansson
13-850-17
17 cm



1/2
Cleveland
13-851-14
14 cm



1/2
Cleveland
13-853-17
17 cm



1/2
Mead
13-855-16
16.5 cm

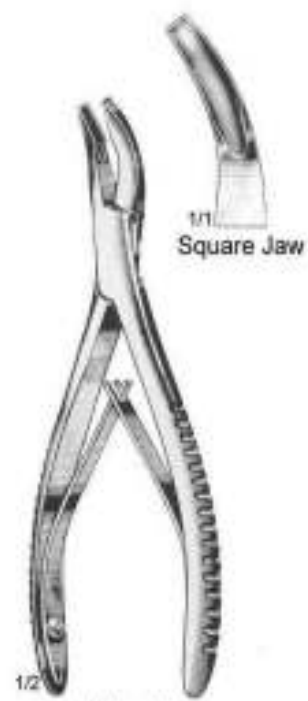

1/2
Mead
13-856-16
16.5 cm

Bone Surgery - Knochenchirurgie - Cirugía ósea
 Bone Rongeur Forceps
 Hohlmeißelzangen
 Pinzas-gubias

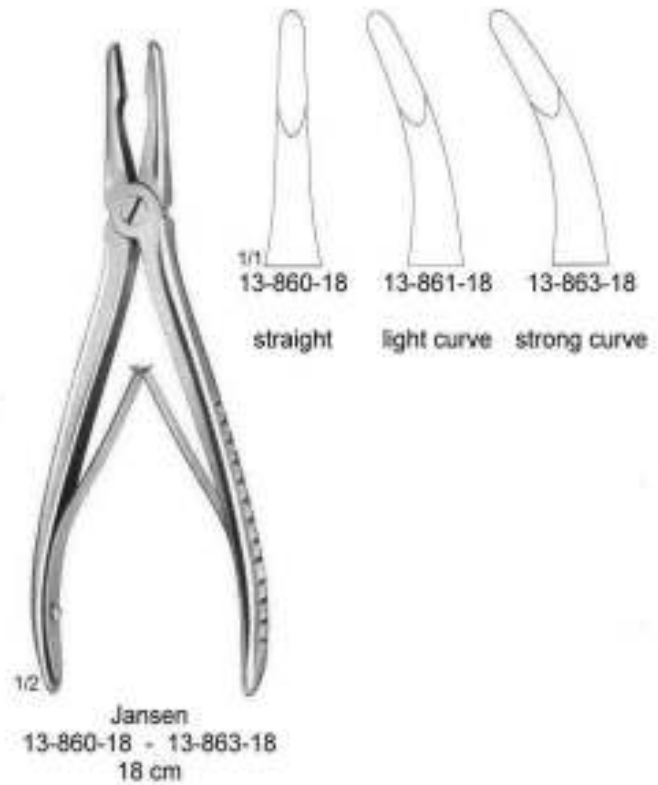
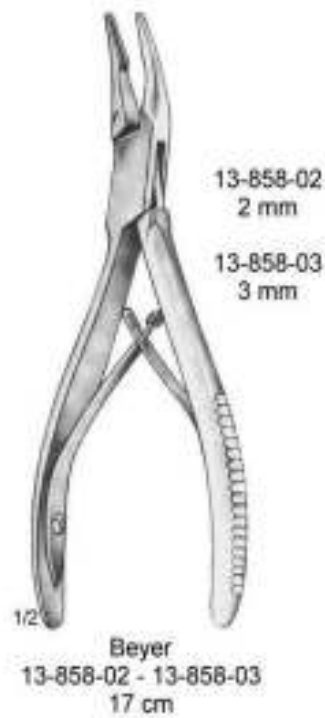

Bone Surgery - Knochenchirurgie - Cirugía ósea
 Bone Rongeur Forceps
 Hohmeißelzangen
 Pinzas-gubias

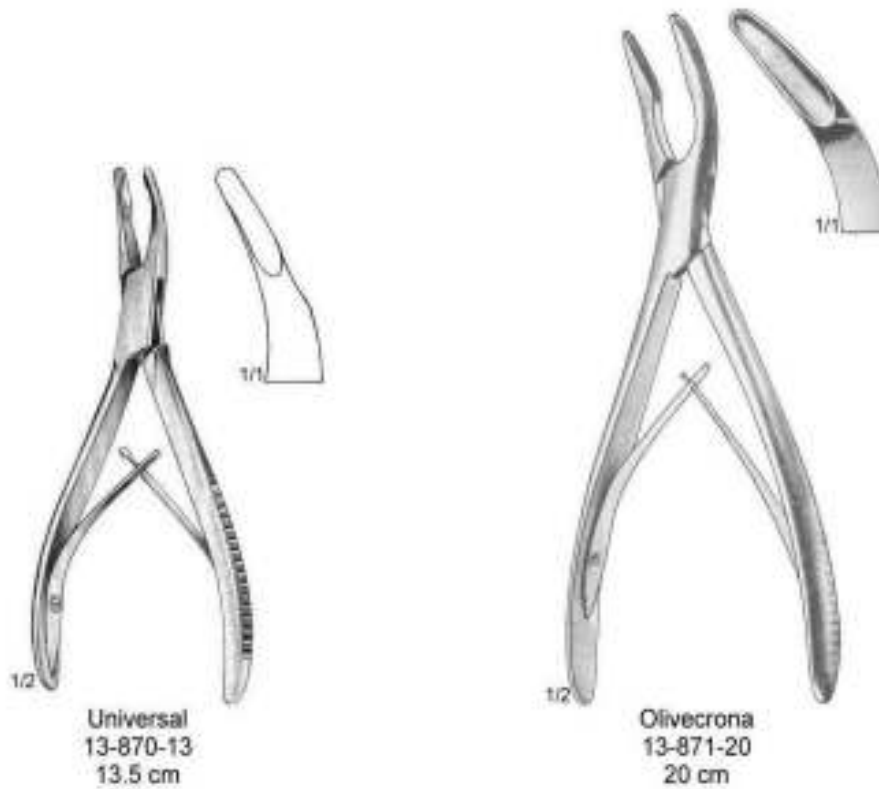
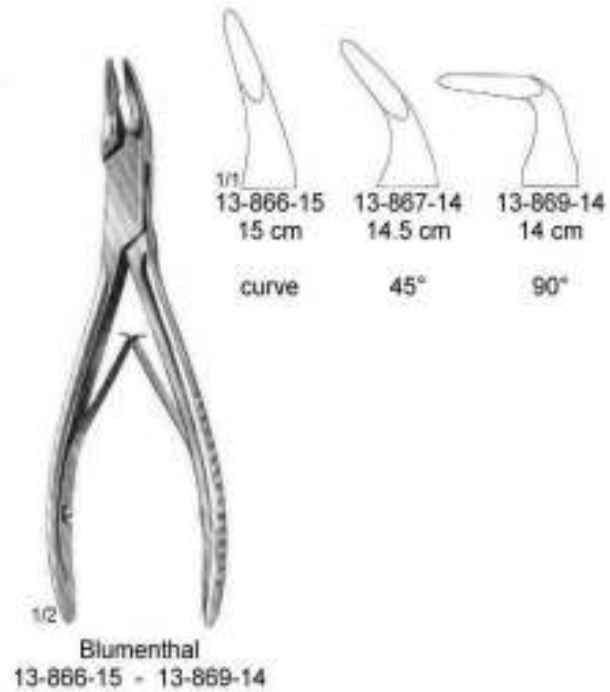
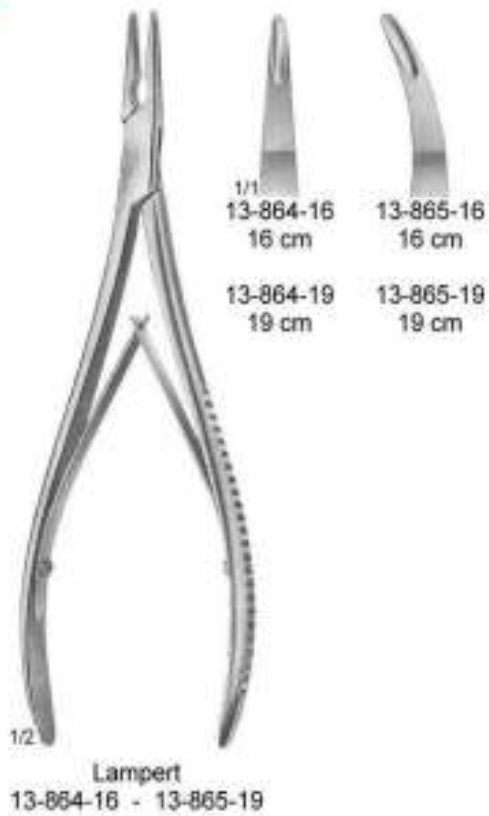

Bone Surgery - Knochenchirurgie - Cirugía ósea
 Bone Rongeur Forceps
 Hohlmeißelzangen
 Pinzas-gubias

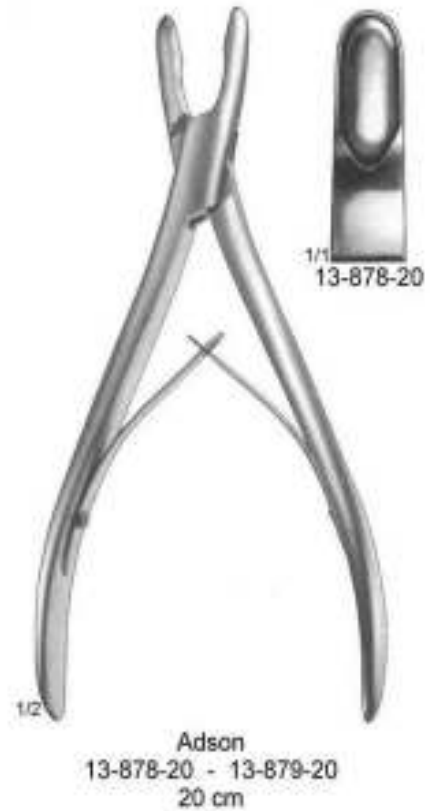
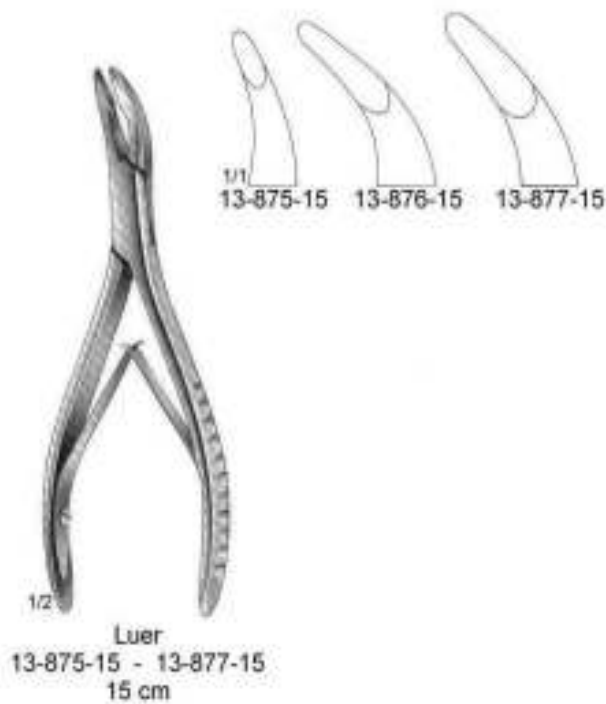
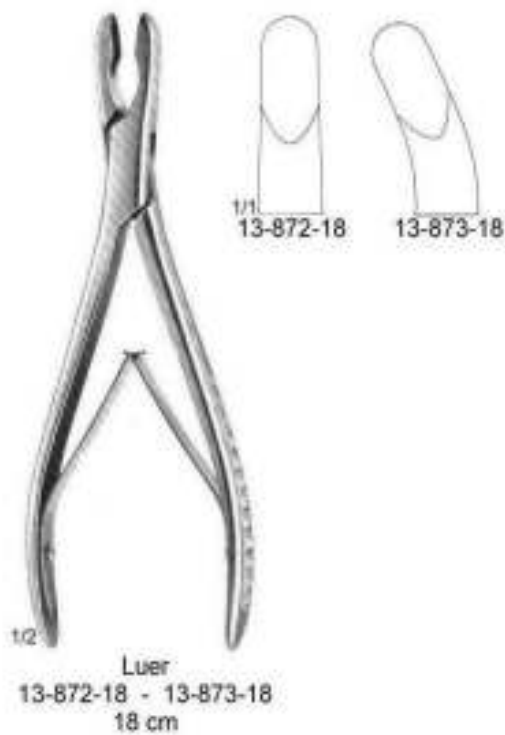

Bone Surgery - Knochenchirurgie - Cirugía ósea
 Bone Rongeur Forceps
 Hohlmeißelzangen
 Pinzas-gubias

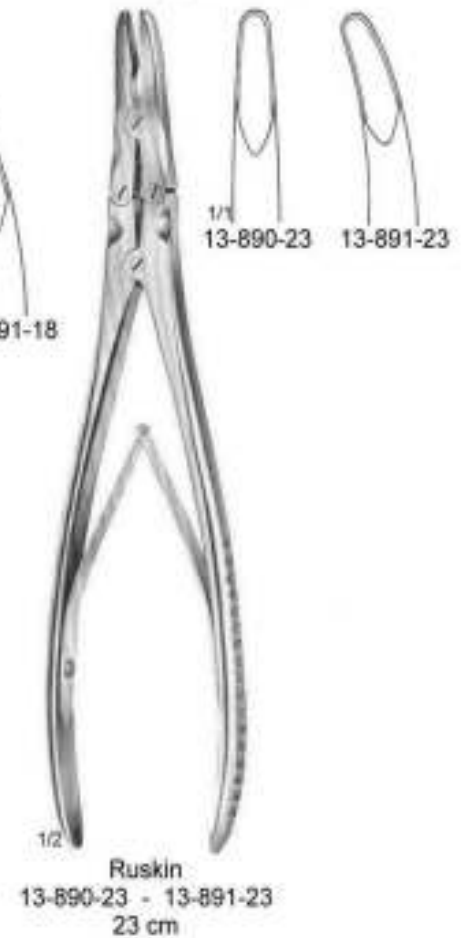
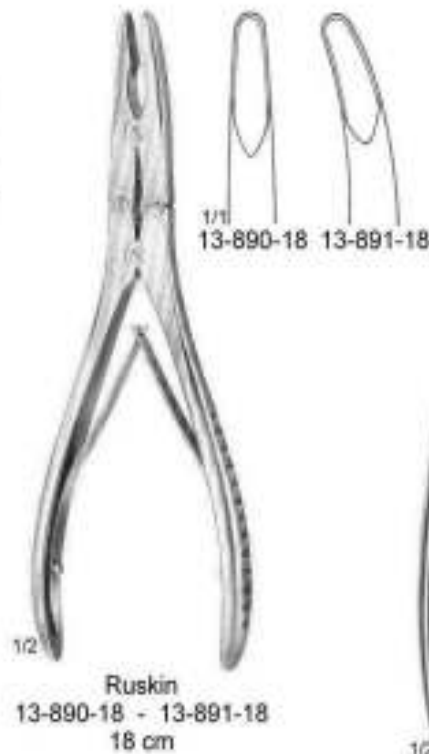
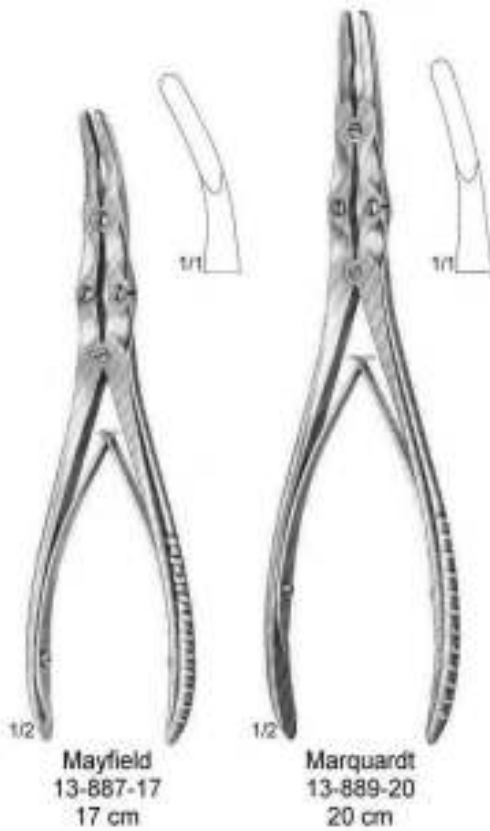
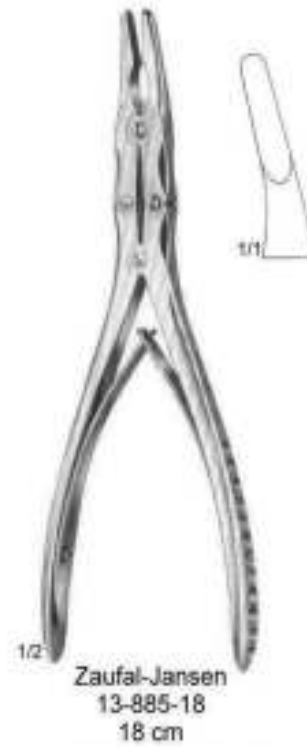
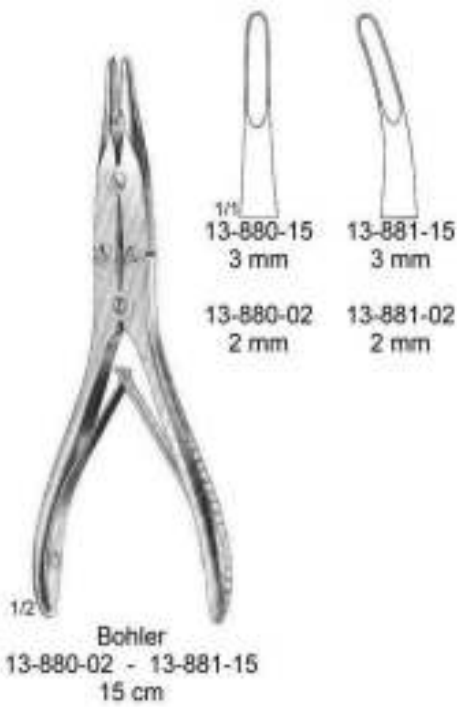

Bone Surgery - Knochenchirurgie - Cirugía ósea
 Bone Rongeur Forceps
 Hohlmeißelzangen
 Pinzas-gubias



Bane
 13-892-01
 18 cm



Zaufal
 13-892-02
 18 cm



Cottle-Jansen
 13-892-03
 18 cm

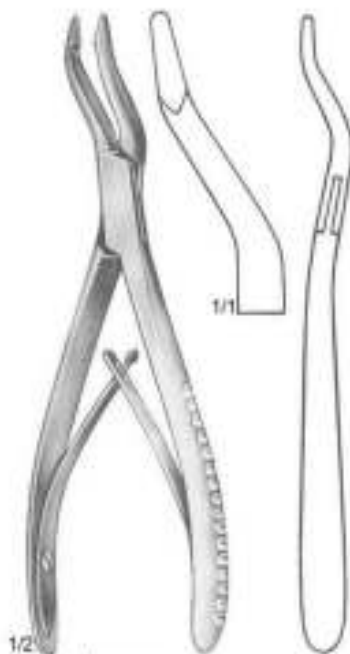

Jansen
 13-892-04
 19 cm



Guleke
 13-892-05
 20.5 cm

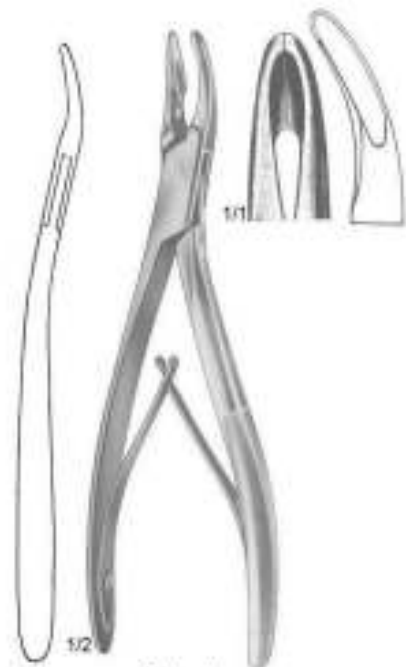

Schell
 13-892-06
 17 cm

Bone Surgery - Knochenchirurgie - Cirugía ósea
 Bone Rongeur Forceps
 Hohlmeißelzangen
 Pinzas-gubias

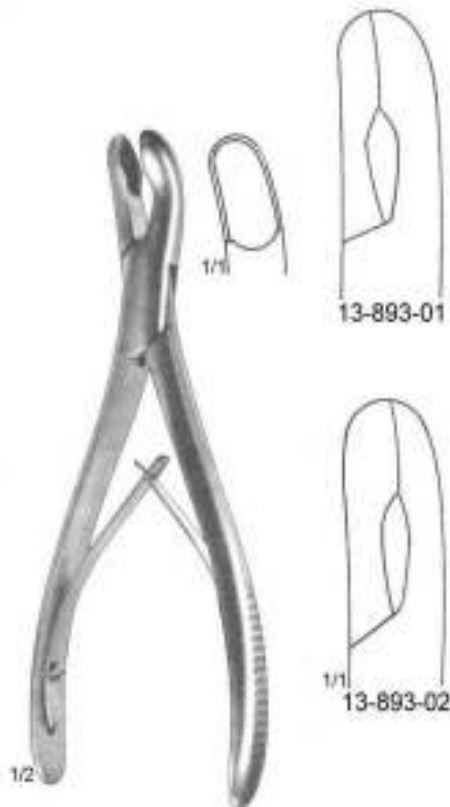

Fisch
 13-893-01 - 13-893-02
 17 cm



Bacon
 13-894-20
 20 cm

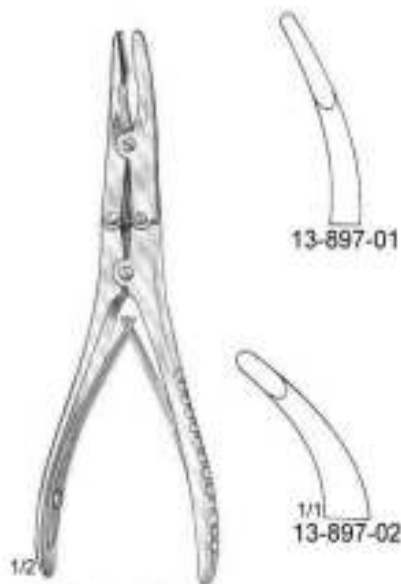

Kleinert-Kutz
 13-897-01 - 13-897-02
 15 cm

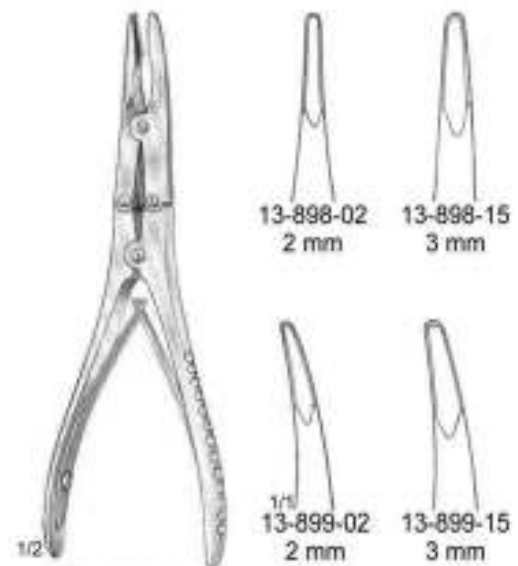

Ruskin-Mini
 13-898-02 - 13-899-15
 15 cm



Bone Surgery - Knochenchirurgie - Cirugía ósea
 Bone Rongeur Forceps
 Hohlemeißelzangen
 Pinzas-gubias

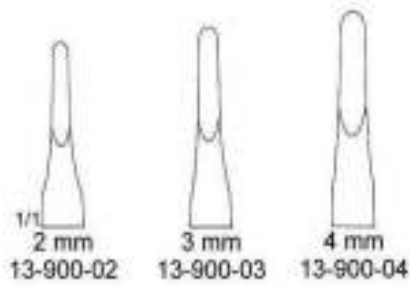

Echlin
 13-900-02 - 13-900-04
 23 cm



Smith Petersen
 13-902-01 - 13-902-03
 24 cm

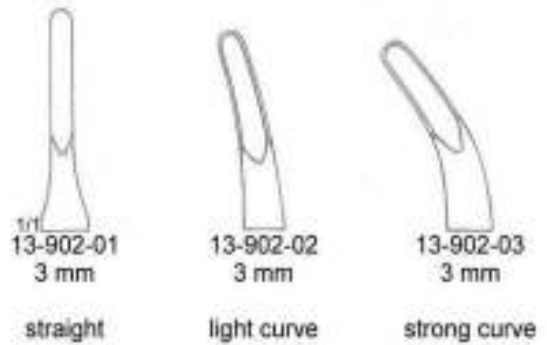



Bone Surgery - Knochenchirurgie - Cirugía ósea
Bone Rongeur Forceps
Hohlmeißelzangen
Pinzas-gubias



Semb
13-903-22 22.5 cm
13-903-27 27.0 cm



Stille
13-904-23
23 cm

Bone Surgery - Knochenchirurgie - Cirugia ósea
 Bone Rongeur Forceps
 Hohlimeißelzangen
 Pinzas-gubias

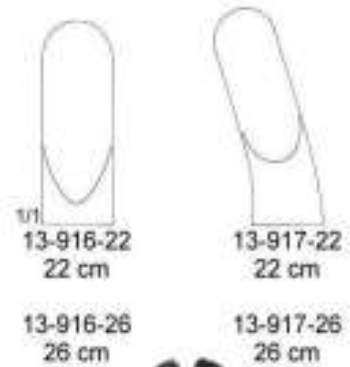
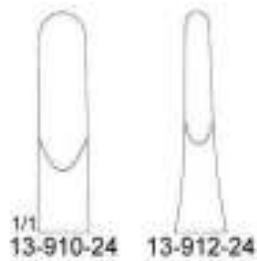

Leksell-Stille
 13-910-24 - 13-912-24
 24 cm



Frykholm
 13-914-24
 24 cm



Stille-Luer
 13-916-22 - 13-917-26



Bone Surgery - Knochenchirurgie - Cirugía ósea
Bone Rongeur Forceps
Hohlmeißelzangen
Pinzas-gubias



Roettgen-Ruskin
13-921-24
24 cm



Stille-Ruskin
13-923-23
23 cm



Bone Surgery - Knochenchirurgie - Cirugia ósea
Bone Rongeur Forceps
Hohlimeißelzangen
Pinzas-gubias

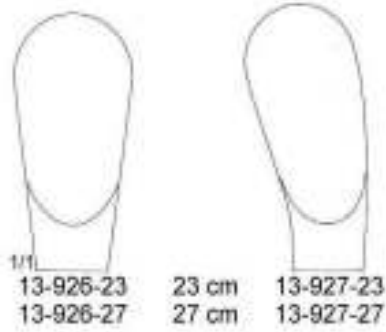

Stille-Luer
13-926-23 - 13-927-27



Sauerbruch
13-930-30 - 13-932-30
30 cm

Bone Surgery - Knochenchirurgie - Cirugía ósea
 Bone Rongeur Forceps
 Hohlimeißelzangen
 Pinzas-gubias

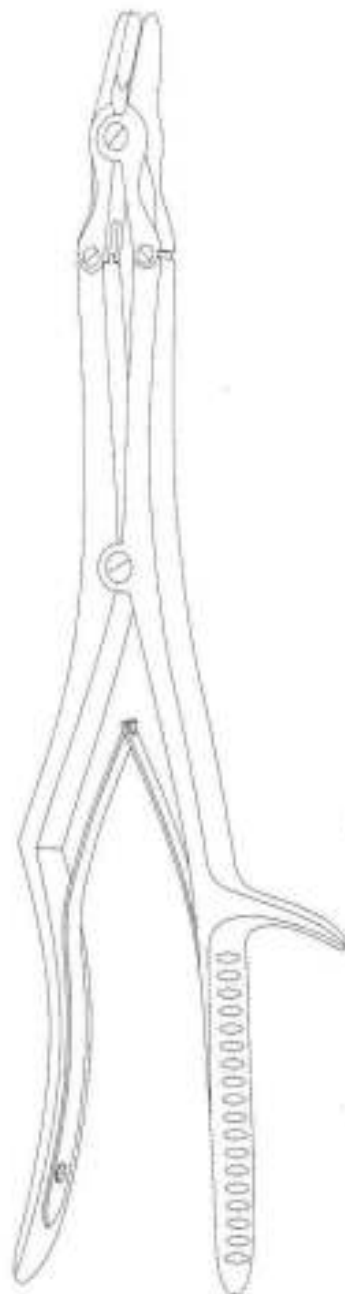

Syvert
 13-936-03 - 13-936-08
 35 cm

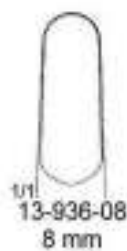
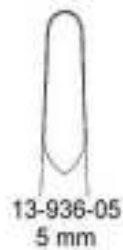

Dale
 13-937-03 - 13-937-08
 35 cm

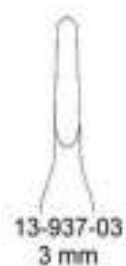

Bone Surgery - Knochenchirurgie - Cirugía ósea
 Bone Cutting Forceps
 Knochensplitterzangen
 Pinzas cortantes para huesos



Cottle Kazanjian
 13-940-19
 19 cm

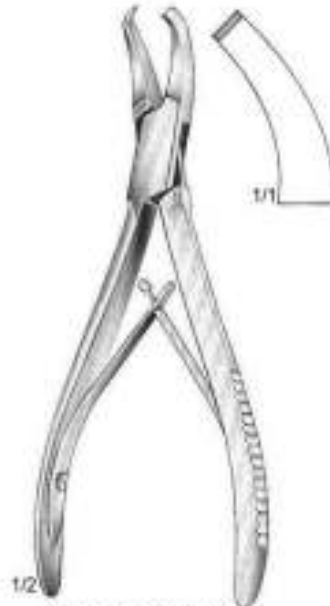

Cleveland-Gardner
 13-941-16
 16 cm



Markwalder
 13-943-20
 20 cm

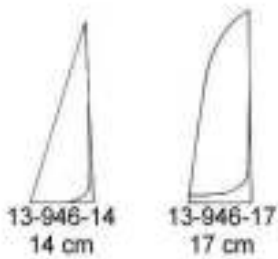

13-946-14
 14 cm

13-946-17
 17 cm

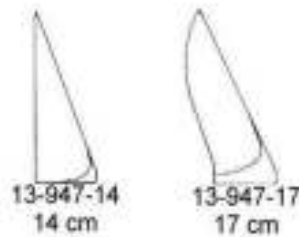

13-947-14
 14 cm

13-947-17
 17 cm

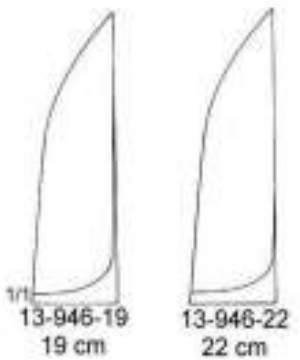

13-946-19
 19 cm

13-946-22
 22 cm



Liston
 13-946-14 - 13-947-22

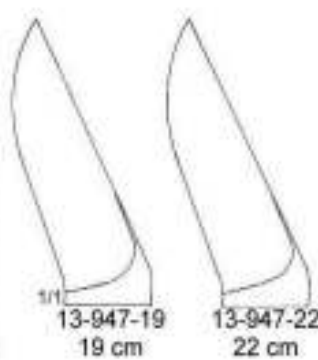

13-947-19
 19 cm

13-947-22
 22 cm



Littauer-Liston
 13-948-15
 15 cm

Bone Surgery - Knochenchirurgie - Cirugía ósea
 Bone Cutting Forceps
 Knochensplitterzangen
 Pinzas cortantes para huesos

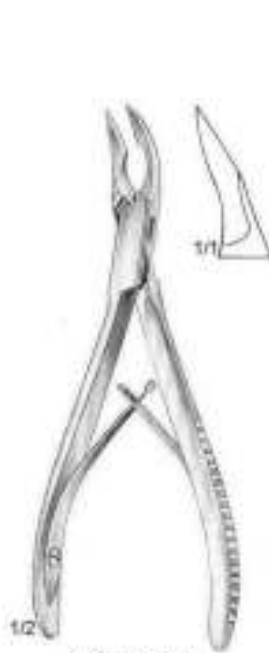

Cleveland
 13-951-15
 15 cm



Cleveland
 13-951-17
 17 cm



Kleinert-Kutz
 13-952-15 - 13-953-15
 15 cm

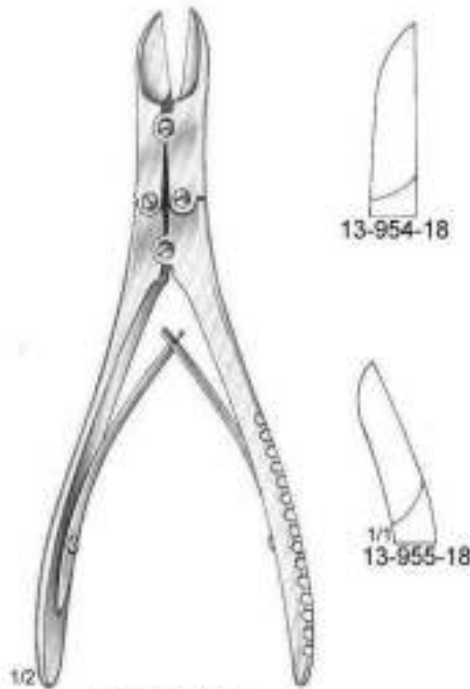

Ruskin-Liston
 13-954-18 - 13-955-18
 18 cm



McIndoe
 13-957-17
 17.5 cm

Bone Surgery - Knochenchirurgie - Cirugía ósea
 Bone Cutting Forceps
 Knochensplitterzangen
 Pinzas cortantes para huesos



Bohler
 13-960-15
 15 cm

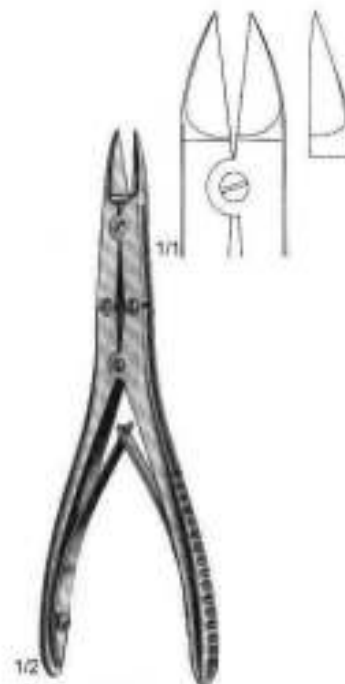

Bohler
 13-961-15
 15 cm

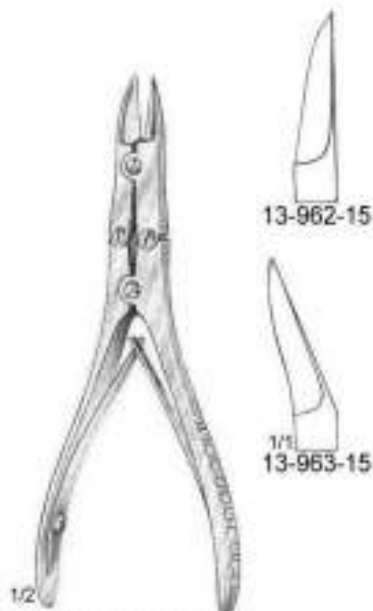

Walton-Liston
 13-962-15 - 13-963-15
 15 cm



13-965-12
 12 cm

Bone Surgery - Knochenchirurgie - Cirugía ósea
 Bone Cutting Forceps
 Knochensplitterzangen
 Pinzas cortantes para huesos



Liston-Key
 13-972-27
 27 cm

(Stille-Horsley)



Semb
 13-973-24
 24 cm



Bone Surgery - Knochenchirurgie - Cirugia ósea
 Bone Cutting Forceps
 Knochensplitterzangen
 Pinzas cortantes para huesos

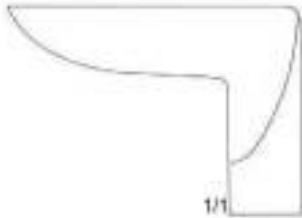

1/1



1/1
13-978-27

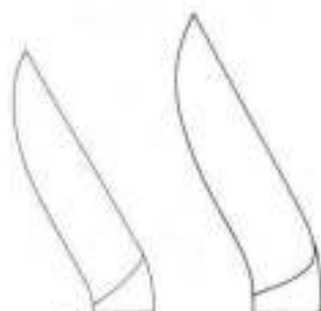

1/1
13-979-23

13-979-27



1/2

Stille-Liston
13-976-27
27 cm



Stille-Liston
13-978-23 23 cm
13-978-27 27 cm



Stille-Liston
13-979-23 23 cm
13-979-27 27 cm

Bone Surgery - Knochenchirurgie - Cirugía ósea
Nail Instruments, Finger Ring Saws
Instrumente für Zehennägel, Fingerringsägen
Instrumentos para uñas, Sierras para abrir anillos



13-981-01
only saw

1/2
Mod. Martin
13-980-17
17 cm



13-983-01
only saw

1/2
Walton
13-982-16
16 cm



13-985-01
only saw

1/2
13-984-17
17 cm



1/2
Penner
13-986-15
15.5 cm

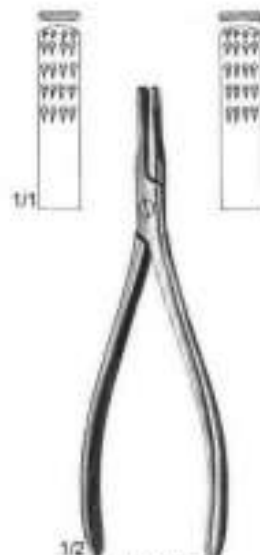

1/2
Radolf
13-988-13
13.5 cm



1/2
13-989-14
14.5 cm



Bone Surgery - Knochenchirurgie - Cirugía ósea
 Wire Instruments
 Drahtinstrumente
 Instrumentos para alambre

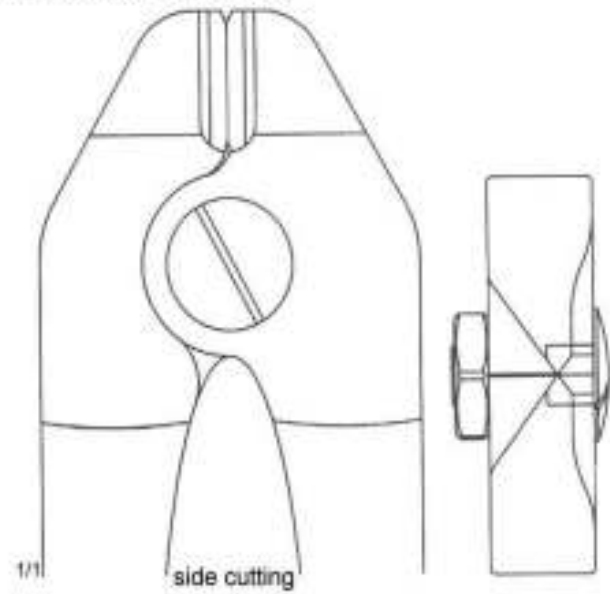
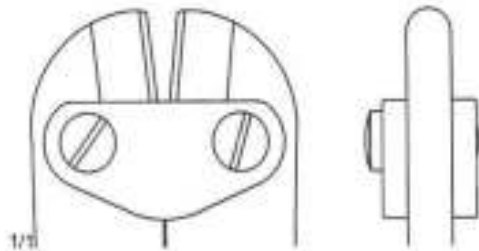

for wires upto
 Ø 3.2 mm



Pin Cutter Double Action
 13-990-23
 23 cm

for wires upto
 Ø 4.0 mm

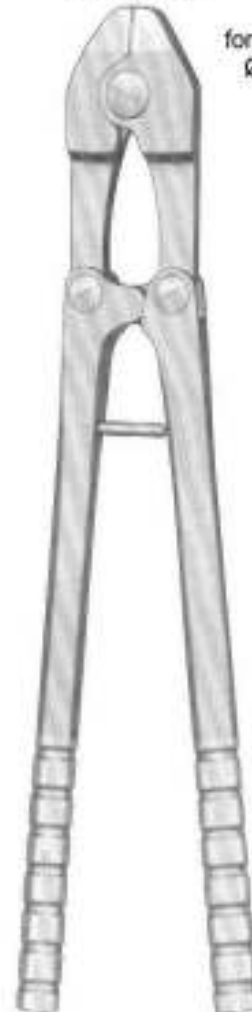

Side Pin Cutter - TC
 13-992-37
 37.5 cm

Bone Surgery - Knochenchirurgie - Cirugía ósea
 Wire Instruments
 Drahtinstrumente
 Instrumentos para alambre

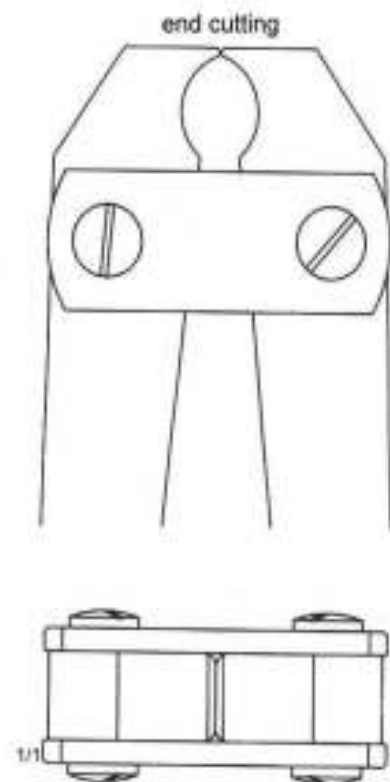



Bone Surgery - Knochenchirurgie - Cirugía ósea
Wire Instruments
Drahtinstrumente
Instrumentos para alambre

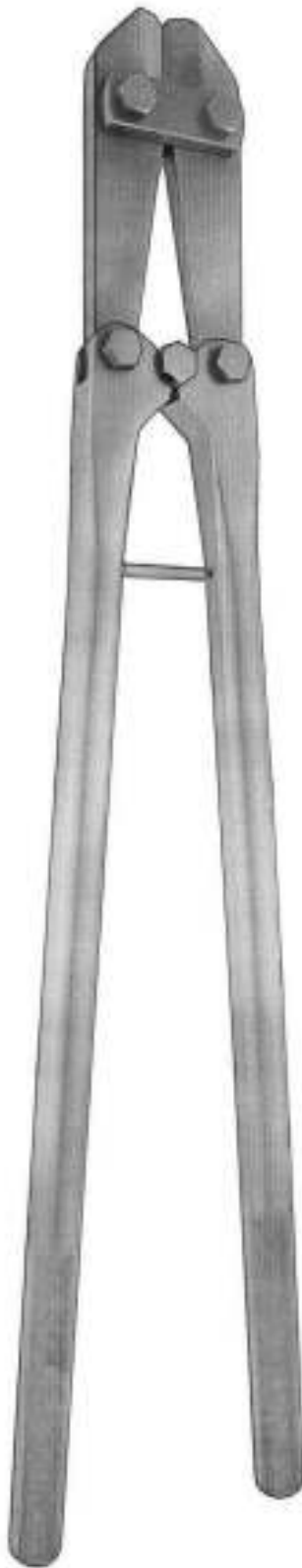

Pin Cutter (Large)
13-998-46 46 cm
13-998-54 54 cm

for wires upto
Ø 6.0 mm

Bone Surgery - Knochenchirurgie - Cirugía ósea
 Wire Instruments
 Drahtinstrumente
 Instrumentos para alambre



| | | |
|-----------|-------|----------------|
| | | for wires upto |
| 13-999-38 | 38 cm | Ø 5.0 mm |
| 13-999-45 | 45 cm | Ø 6.0 mm |
| 13-999-56 | 56 cm | Ø 7.5 mm |

Pin Cutter
 13-999-38 - 13-999-56



Orthopaedics - Orthopädic - Ortopedia
Tap & Drill Holders, Screw Drivers, Drill Bits
Handstücke, Schraubendreher, Spiralbohrer
Mangos para terrajas y toladros, Destornilladores, Broca



T - Handle
33-100-00



Handle For AO Attachment
33-110-00



Dental Handle
33-120-00



33-130-15
1.5 mm



33-130-25
2.5 mm



33-130-35
3.5 mm



| AO | Ø mm | mm |
|-----------|------|-----------|
| 33-150-11 | 1.1 | 60 / 35 |
| 33-150-15 | 1.5 | 85 / 60 |
| 33-150-20 | 2.0 | 100 / 75 |
| 33-150-25 | 2.5 | 110 / 85 |
| 33-150-27 | 2.7 | 100 / 75 |
| 33-150-32 | 3.2 | 145 / 120 |
| 33-150-35 | 3.5 | 110 / 85 |
| 33-150-45 | 4.5 | 145 / 120 |
| 33-150-60 | 6.0 | 195 / 170 |



| AO | Ø mm |
|-----------|------|
| 33-156-15 | 1.5 |
| 33-156-20 | 2.0 |
| 33-156-27 | 2.7 |
| 33-156-35 | 3.5 |
| 33-156-45 | 4.5 |
| 33-156-65 | 6.5 |



Orthopaedics - Orthopädic - Ortopedia
Bone Nailing Instruments
Instrumente zur Knochenogelung
Instrumentos para el endavamiento de huesos



Kuentscher
33-180-08 8 mm
33-180-10 10 mm
33-180-12 12 mm
26 cm



Kuentscher
33-186-63
63 cm



Kuentscher
33-186-01
Fig 1



Kuentscher
33-186-02
Fig 2

33-188-00 (33-186-01 + 33-186-02 + 33-186-63)



Orthopaedics - Orthopädic - Ortopedia
Bone Nailing Instruments
Instrumente zur Knochenogelung
Instrumentos para el endavamiento de huesos



Extraction Hook
33-200-29 29 cm
33-200-37 37 cm
33-200-42 42 cm
33-200-49 49 cm



Slotted Hammer
33-210-30
30 cm



Lloyd Impactor
33-220-20
20 cm



Orthopaedics - Orthopädic - Ortopedia
Screw Drivers
Schraubendreher
Destornilladores

Handle from artificial wood

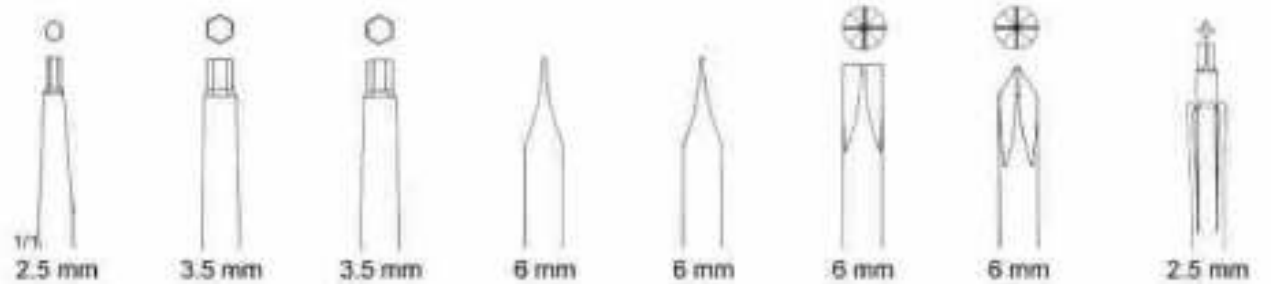

33-280-25
25 cm

33-282-21
21 cm

33-282-25
25 cm

33-286-17
17 cm

Lane
33-286-25
25 cm

33-290-25
25 cm

Philips
33-292-25
25 cm

33-294-19
19.5 cm



Orthopaedics - Orthopädic - Ortopedia
Screw Drivers
Schraubendreher
Destornilladores



Philips Head
33-300-01



Slotted Head
33-300-02



Single Head
33-300-03



Hexagonal Head
33-300-04



Williams
33-300-01 - 33-300-04
24 cm



Orthopaedics - Orthopädic - Ortopedia
Instruments for Bone Plates & Screws
Instrumente für Knochenplatten und schrauben
Instrumentos para placas y tornillos para huesos



Holding Forcep For Small Plates
 33-360-12
 12 cm



Screw Holding Forcep
 33-374-08
 8 cm



Bending Iron For Small Plates
 33-390-13 33-394-01 33-394-02
 13 cm 14.5 cm 14.5 cm



Bending Iron For Large Plates
 33-400-24 Solid
 33-402-24 Light Weight
 24 cm



Bending Plier
 33-410-14
 14 cm



Bending Plier
 33-414-14
 14 cm

1.5 / 2 mm Plate



Orthopaedics - Orthopädic - Ortopedia
Instruments for Bone Plates, Tap & Screw Drivers
 Instrumente für Knochenplatten, Gewindescheider, schraubendreher
 Instrumentos para placas o' seas Terrajas y destornilladores



Bending Press
33-440-00



Tap & Drill Sleeve
33-500-00
2.7 / 1 mm



Tap
33-520-35 Ø 3.5 mm
33-520-45 Ø 4.5 mm
33-520-70 Ø 7.0 mm



Hexagonal Key
33-530-40 4.0 mm
33-530-45 4.5 mm
33-530-70 7.0 mm



Hexagonal Screw Driver
33-540-25 2.5 mm
33-540-35 3.5 mm



33-550-50
5 mm

Orthopaedics - Orthopädic - Ortopedia
Osteosynthesis Instruments, Counter Sinks
Instrumente zur Osteosynthese, Kopfraumfräser
Instrumentos para osteosintesis, Avellanadores



Parallel Aiming Device For Guide Ø 2 mm
33-600-02



Tissue Protector Sleeve For Cannulated Screws Ø 7 mm
33-610-07

1.1 mm



Counter Sink
33-620-11

For Mini Screws
1.5 / 2 mm

2 mm



Counter Sink
33-620-20

For Small Screws
2.7 / 3.5 / 4 mm

3.2 mm



Counter Sink
33-620-32

For Malleolar Screws
4.5 mm

4.5 mm



Counter Sink With T-Handle
33-624-45

For Large Screws
4.5 / 6.5 mm



Orthopaedics - Orthopädic - Ortopedia
 Osteosynthesis Instruments, Depth Guages
 Instrumente zur Osteosynthese, Tiefenmessgeräte
 Instrumentos para osteosintesis, Medidores de profundidad



Insert Drill Sleeve
 33-650-27 2.7 / 2.0 mm
 33-650-35 3.5 / 2.5 mm
 33-650-45 4.5 / 3.2 mm



Mini Drill Sleeve
 33-660-11 1.1 / 1.5 mm
 33-660-15 1.5 / 2.0 mm



Triple Drill Guide & Sleeve
 33-666-20
 2 mm

Sharp



Hooklet
 33-680-15
 15.5 cm



33-700-00

Mini



33-704-00

Small



33-708-00

Large



Orthopaedics - Orthopädic - Ortopedia
Osteosynthesis Instruments
Instrumente zur Osteosynthese
Instrumentos para osteosintesis



Pointed Drill Guide
33-740-45



Drill Guide With Two Inserts
33-744-45



Tap Sleeve 3.5 mm For Tap 2.7 mm
33-748-35



Tap & Drill Sleeve
33-752-27 2.7 / 2.0 mm
33-752-35 3.5 / 2.5 mm



Tap Sleeve For Large Cannulated Screws
33-756-45
4.5 mm

Orthopaedics - Orthopädic - Ortopedia
Osteosynthesis Instruments, Double & Universal Drill Guides
Instrumente zur Osteosynthese, Doppel und Universal-Bohrbüchsen
Instrumentos para osteosíntesis, Guías de brocas doblas y universales



Drill Sleeve For Tension Device
 33-760-32
 Ø 3.2 mm



40 mm
 Drill Guide For Round Hole Plates For Drill Bits
 33-764-40
 Ø 3.2 mm



60 mm
 33-764-60
 Ø 3.2 mm



Double

33-780-45
 4.5 / 3.2 mm



Double

33-784-32
 3.2 / 6.5 mm



Universal

33-790-25
 2.5 mm



Universal

33-794-32
 3.2 / 4.5 mm



Orthopaedics - Orthopädic - Ortopedia
Compression Devices, Socket & Combination Wrenches
Platten Spanner, Schraubenschlüssel
Compresores de placas, Llaves para tuercas



Hub
33-800-20
20 mm



Ø 4.5 mm

Pin Wrench
33-804-12
12 cm



Spanner
33-810-11
11 mm



33-816-11
11 mm



Orthopaedics - Orthopädic - Ortopedia
 Drill Guides, Wire Instruments
 Bohrbüchsen, Instrumente für Draht
 Guías de broca, Instrumentos para alambre



Neutral Drill Guides
 33-840-20 2.0 mm
 33-840-27 2.7 mm
 33-840-35 3.5 mm
 33-840-45 4.5 mm



Neutral Drill Guides
 33-846-60
 4.5 mm



Wire Tightner
 33-870-01



Wire Tightner
 33-870-02



Bending Iron For Wire Drills
 33-880-00



Orthopaedics - Orthopädic - Ortopedia
Screw Driver with Interchangeable Blades
Schraubendreher mit auswechselbaren Klängen
Destornillador con hojas intercambiables

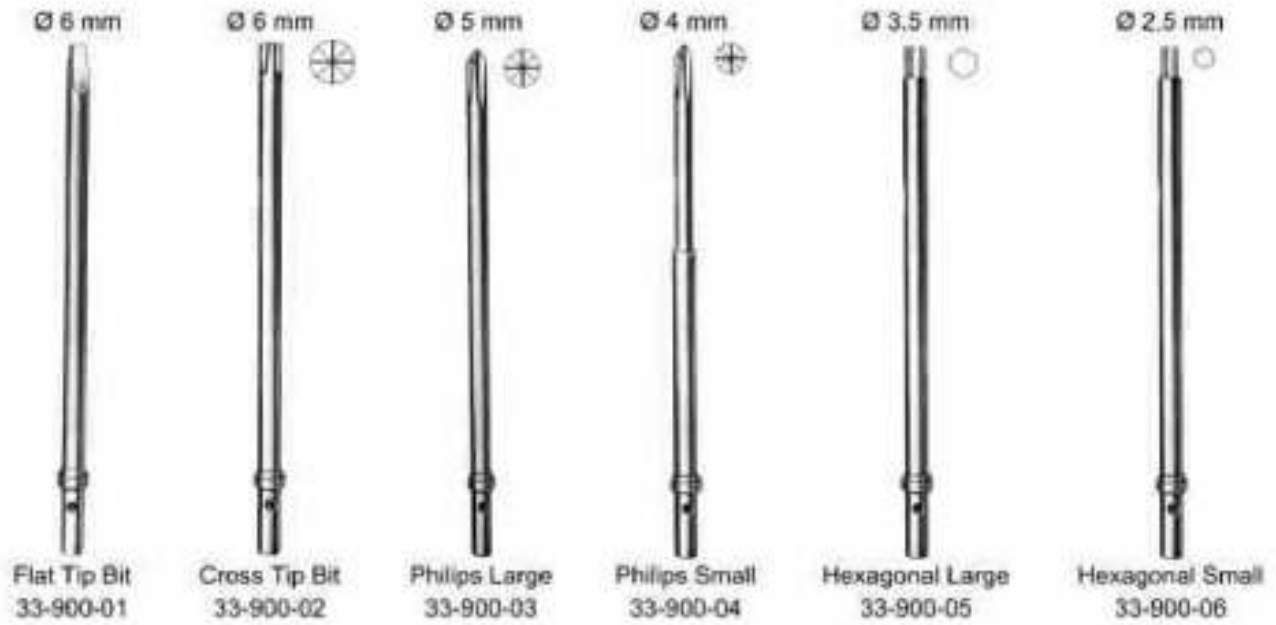

Screw Driver With Bore & Quick Action Chuck
33-900-10

33-906-00 (33-900-01 - 33-900-10)
Complete



Orthopaedics - Orthopädic - Ortopedia
 Instruments for Dynamic Hip Screws
 Instrumente für Dynamische Hüftschrauben
 Instrumentos para tornillos dinámicos femorales

Ø 2.5 mm



Threaded Guide Pin
 33-950-01
 23 cm

Adjustable
 135° / 140° / 145° / 150°



Aiming Device
 33-950-02



Guide Wire
 33-950-03



Triple Combo Reamer
 33-950-04



Tap
 33-950-05



Short
 Guide Sleeve
 33-950-06



Long
 Guide Sleeve
 33-950-07



Orthopaedics - Orthopädic - Ortopedia
Instruments for Dynamic Hip Screws
Instrumente für Dynamische Hüftschrauben
Instrumentos para tornillos dinámicos femorales



Guide Shaft
33-950-08



Guide Shaft
33-950-09

Coupling Screw
33-950-10

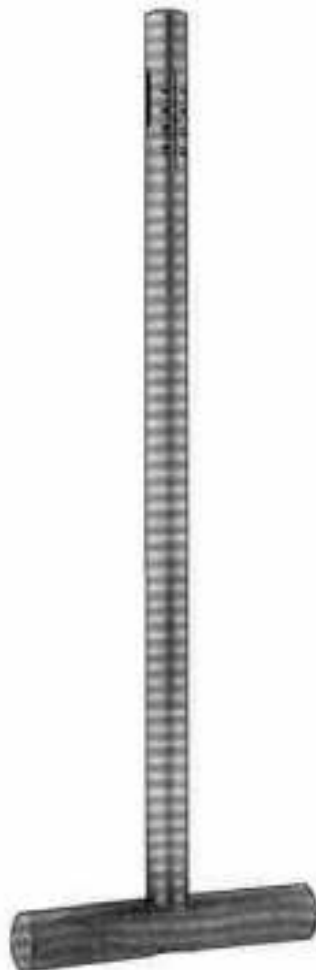

Wrench
33-950-11



Impactor
33-950-12

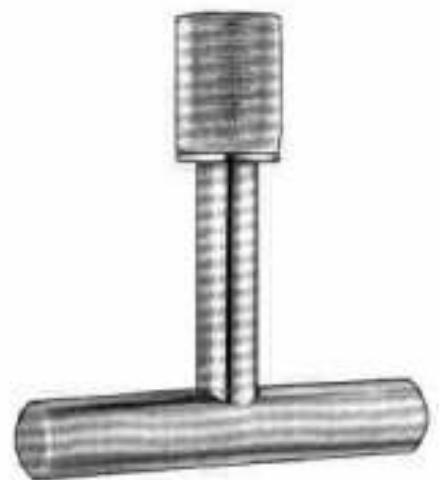

T-Handle
33-950-13



Orthopaedics - Orthopädic - Ortopedia
Optional Instruments
Optionale Instrumente
Instrumentos opcionales



Plate Bending Plier
33-970-16
16 cm